



British Horology Times

June 2014

Number 62

British Horology Chapter 159 of the National Association of Watch and Clock Collectors, Inc

A Brief History of the Great Clock at Westminster Palace Its Concept, Construction, the Great Accident and Recent Refurbishment

By Mark R. Frank ©2008

Introduction: Big Ben is a character, a personality, the very heart of London, and the clock tower at the Houses of Parliament has become the symbol of Britain. It is the nation's clock, instantly recognizable, and brought into Britain's homes everyday by the BBC. It is part of the nation's heritage and has long been established as the nation's timepiece heralding almost every broadcast of national importance.



Clock in northern tower, Westminster

On the morning of August 5th 1976 at 3:45 AM a catastrophe occurred to the movement of the great clock in Westminster Palace. The damage was so great that for a brief time it was considered to be beyond repair and a new way to move the hands on the four huge exterior dials was considered. How did this happen and more importantly why did this happen and how could such a disaster to one of the world's great horological treasures be prevented from happening again?

Let us first go through a brief history leading up to the creation of the clock. Then its manufacture and installation into the tower. This second issue - the configuration of the tower and the installation needed to accommodate the tower design will become key to the understanding of the source of the accident.

(Continued on page 3)

Officers of British Horology Chapter 159

Richard Newman, President
rpnewman@yahoo.com
630-207-6616

Dennis Radage, Vice President
finelocks@outlook.com
604-921-1666

Marion Krajewski, Secretary
bm177@sbcglobal.net
219-769-8247

Peter Stipanovich, Treasurer
1305 Aviara Place
Gibsonia, PA 15044
440-476-9776
pstipanovich@gmail.com

Editor

Open position – please volunteer!

Frank Del Greco, Advisor
fdelgreco@aol.com
440-338-8261

British Horology Times

Is a newsletter of British Horology Chapter 159
of the National Association of
Watch and Clock Collectors, Inc.

Correspondence and manuscripts should be sent
to the email britishhorology@gmail.com
Applications for membership and payment of
dues should be sent to the Treasurer
(see address above)

Annual membership costs \$5.00
Worldwide. See website for details.

www.britishhorology.nawcc.org

Opinions expressed in articles in this newsletter
are those of the writers and are not necessarily
endorsed by the Chapter and/or by the
National Association of
Watch and Clock Collectors, Inc.

© Copyright 2014 by British Horology
Chapter 159

Presidents Message:

Dear friends,

We received a wonderful lecture by Mark Frank at our last meeting at the Southern Ohio Regional and he has graciously agreed to allow us to publish his entire talk in this expanded special addition of BHT.

This is possible due to BH volunteers that have provided an increased level of support to NAWCC events, including the last National Convention in Dayton, resulting in a significant windfall to our financial position. Please consider volunteering your time at the National Convention. We also need your urgent help to contribute articles for future newsletters . We would be pleased to collaborate with you to research or edit any topics that would be of interest to chapter members. Just do it!

Look for the Union Jack in the Mart and stop by to chat.

See you in Milwaukee!

Rich

Next Meeting

National Convention

Milwaukee, June 17-21

“The English Longcase Clock”

See details about this talk by Dennis Radage on
our website and the NAWCC National
Convention information page. Also be sure to
attend general session lectures given by
Dennis & Laila Radage, and Rich Newman

History of Westminster:

Despite its ancient Gothic appearance, the clock tower, and the present Houses of Parliament came into being only after a fire destroyed the ancient Palace of Westminster on October 16, 1834. The fire was started because cancelled wooden tallies, which were used as treasury receipts prior to 1812, were being burned in the central boiler instead of the usual coke. The stokers over-stocked the boiler and left their duty early hoping that their fire would last the night and it certainly did! It was unfortunate that an overheated flue set fire to the whole complex of buildings.¹



Old Westminster Palace, courtyard



The burning of the old Palace, 1834

There had been a clock tower in the old palace since 1290. The story behind that clock is quite colorful. In the year of 1288 a gentleman by the name of Sir Ralph-de-Hengham, Chief Justice of the King's Bench had caused a Court Roll to be erased, to enable someone's fine to be reduced. He was caught. For his offense he was fined 800 Pounds, (£) - (£498,000, \$797,000 today ²), by King Edward I, and this money was used for the building of a tower containing the clock and bell. This may seem like quite a hefty fine, but compared to common punishments of the time, was quite lenient as he could have easily been imprisoned or worse for his transgression. The Bell known as Great Tom of Westminster struck the hours. It is said that this was to remind the judges, who were sitting in the ancient Courts of Westminster Hall, of Sir Ralph's offense. The bell, which weighed 4 tons, 300 lbs, was given in 1699 by William III to the new cathedral of St. Paul's with the idea that it should be mounted in one of the towers. Unfortunately it was broken in transit, and the site of the accident became known as Bell Yard in the Strand.

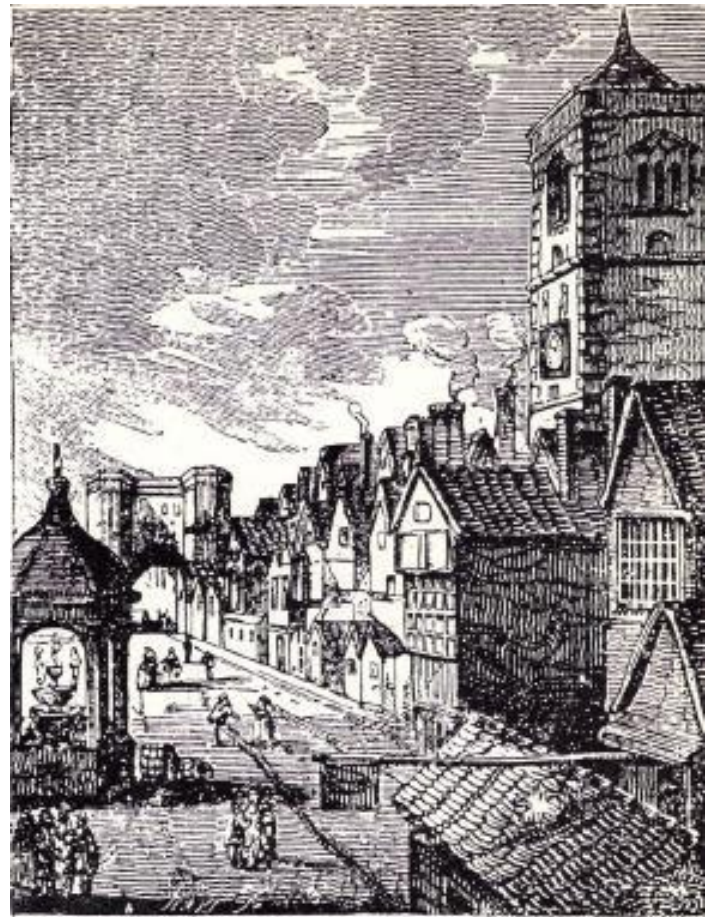

Old Westminster Palace clock tower



Charles Barry

The broken bell was melted down and recast twice by Phillip Wightman, in about 1710, but it was unsatisfactory. Richard Phelps of Whitechapel Foundry then undertook the recasting, and by adding extra metal he succeeded in producing a good bell in 1716. That bell still strikes in St. Paul's today. Whitechapel is also still in business today.

Westminster was therefore left with a clock but no bell in 1699, but the tower was crumbling and in 1707 it was demolished, the site being marked by a sundial engraved with a motto from Virgil, translated from the Latin as "Learn the Justice of my advice." The Westminster palace had now lost its bell, its clock and tower. It was not until after the fire which destroyed the palace in 1834 that the architect chosen for the rebuilding, Charles Barry, produced a plan in 1842 for the palace which included a new clock in the northern tower.

The clock's beginnings - competition, intrigues and arrogance:

In March of 1844 Barry decided to approach Benjamin L. Vulliamy, an imminent clockmaker of the day, to give an estimate for the clock. Barry had employed Vulliamy's son from 1836 to 1841 so Barry knew Vulliamy and considered him as a logical choice. Vulliamy knew that this clock was breaking new ground on many fronts, both in accuracy and in size. It was to be the centerpiece of the new palace. The initial specifications called for four dials each being 30 feet across. The hours to be struck on a bell of 8 to 10 tons, with quarters to be played on 8 bells, later reduced to four. The specifications called for an unprecedented accuracy in the strike and time keeping. Size and accuracy are conflicting parameters in clock design and Vulliamy was reluctant to supply all the necessary drawings and specifications as requested by Barry without being guaranteed the commission.

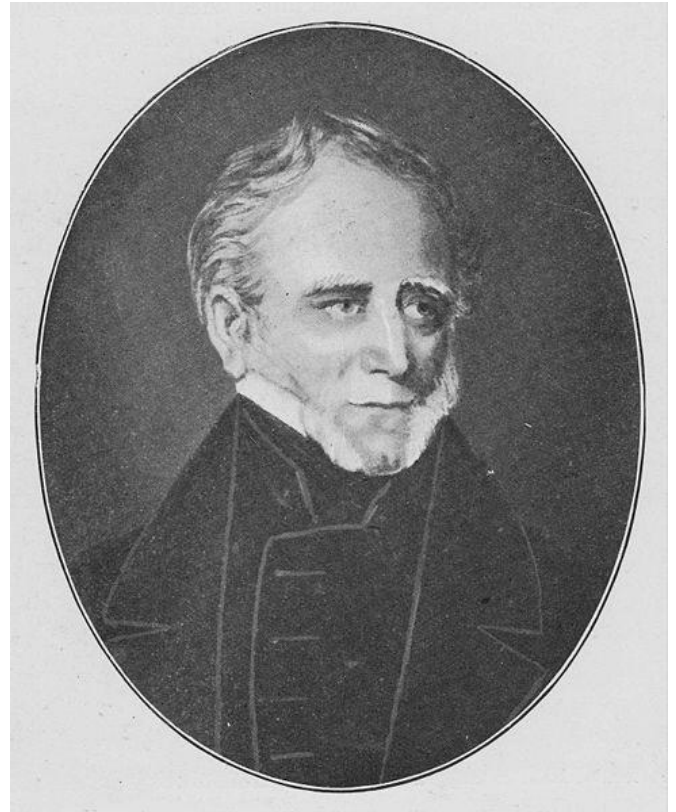

He had, however finally agreed to supply the specifications and drawings with the provision he be paid 100 Guineas (\$10,300 today) ³ and if not accepted for the job, 200 Guineas (\$20,600).⁴ Vulliamy felt he could do this as he was a preeminent clockmaker in Britain and clockmaker to the Queen. Edward Dent, a rival of Vulliamy and whose firm was also engaged in the manufacture of tower as well as domestic clocks, regulators and chronometers, decided to apply for the commission. He knew that winning and successfully building the clock would be a feather in his cap and add greatly to his company's prestige.



Edward John Dent



George B. Airy

Dent had already made a tower clock for the Royal Exchange which had performed admirably. He wrote George Biddle Airy, then Britain's Astronomer Royal in July of 1845 of his intention to apply. Airy was involved with the specifications of the Exchange clock; worked with Dent on it, and appreciated the clock's subsequent success. With Airy's concurrence he applied four months later to the Commissioners of Woods and Forests (The Commission) - the body responsible for overseeing the palace project on behalf of the government and that was to make the final decision on the clock. It appears that the general architect, Charles Barry, did not have this authority.

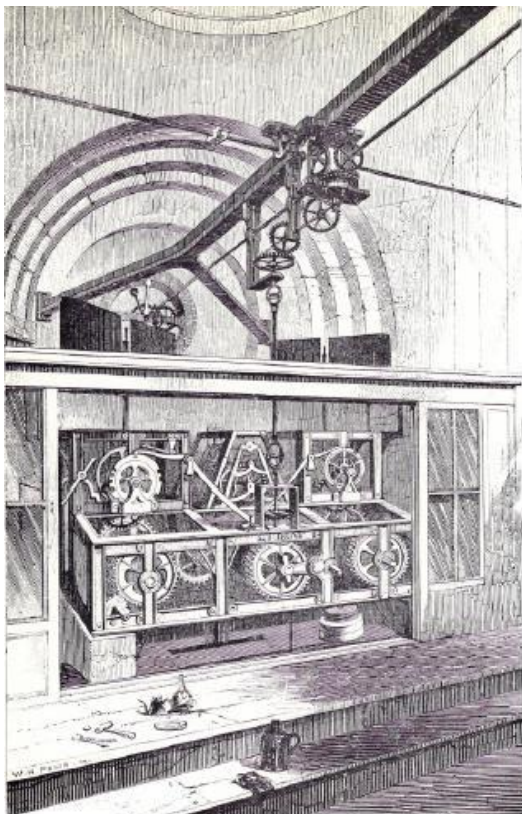

Royal Exchange clock

The Commission informed Dent that Vulliamy was already engaged to make drawings and that if he would make an estimate for the construction of the clock based on those drawings. Dent, wanting to gain prominence by his own hand and not share any credit of his achievement cleverly replied sic. "That if adherence to drawings and specifications to be prepared by another clockmaker were to be stringent on him, he must decline to become a candidate; that he should feel it a duty to comply with any suggestions from the Astronomer Royal, but could not engage to act under the directions of authority less eminent, or to follow instructions, which by degrading him to the position of a mere executive mechanic, would prove detrimental to his reputation." 5 Notice how he praises Airy to further cement his support while giving a backhand to Vulliamy. Not surprisingly relations between Dent and Vulliamy grew more poisonous as time went on. Vulliamy, on the other hand, did not help his position by delaying his quotation and complaining to the Commission about the fact that they were considering another contender. It is interesting to note that in the end Dent indeed did become, or very nearly so, the "executive mechanic" to another's design.

On June 20 of 1846, Viscount Canning, who was now the First Commissioner of the board, wrote to Airy to ask his opinion of the contenders. Airy was now plumped for Dent and wrote back on the 22nd, "A question of similar import was addressed to me in 1843 by the Gresham Committee, in regard to the construction of a clock for the Royal Exchange. In reply I stated that (irrespective of the choice of clockmaker) general conditions ought to be laid down as to the choice of materials, etc., etc., and also that certain specific conditions applying to the accurate going of the clock, suggested by me should be laid down, and that intimation should be given to the clockmaker that his plans were to be submitted to me for my opinion before the work should be commenced. I would therefore propose to the Commissioners of Woods and Works that a similar course should be followed in the instance of the clock for the new palace at Westminster, and if the Commissioners shall think fit to desire my general superintendence in the manner which I have described, I will undertake that the clock which shall be mounted shall be creditable to the nation.

In regard to the selection of a maker, I suggested to the Gresham committee the names of Mr. Vulliamy of London (a maker of some celebrity, but said to be unmanageable in temper and very expensive in prices), and Mr. Whitehurst (a man of reputation in the North of England, and known as the inventor of the Watchman's Clock). By arrangements with which I am not acquainted, the work was placed in the hands of Mr. Dent, chronometer maker of 82 Strand; and I am bound to say that Mr. Dent carried out my views most completely, making, in the mechanical arrangements, which I suggested, some judicious alterations which received my entire approval.*

Under all circumstances, considering that a new clock pretending to a degree of accuracy equal or superior to that of the Royal exchange must probably contain some of Mr. Dent's inventions and would at any rate be improved by his experience - that the trust is, so to speak, in some manner confidential, and that there is no such thing as a market for clocks of this size - I think it would be probably the best course to transmit proposals (including my conditions) to Mr. Dent, and to ask for his tender. If his price should not be excessive I would propose to employ him without inquiry of other makers. If it appeared objectionable I would apply to others, but think (I think) only the two whom I have named."⁶

The fix in favor of Dent by Airy was in.

In July Charles Barry informed Vulliamy that the Commission had decided to accept applications from competitors. Two weeks later Vulliamy replied to say "My general rule of conduct has been in all cases to decline competition" etc., and finally "I have concluded to decline it."⁶ His reasons given appear to be that he objected to Airy being sole referee, and also because Airy appeared to be prejudiced in favor of Dent. He was right, but his attitude throughout this did not help him.

Dent wasted no time and on August 8, 1846 submitted his bid "I hereby agree to complete and erect in the tower, and keep in order for the first twelve months, the clock for the new Houses of Parliament, agreeably to the plans and specifications, and to attend, without additional charge, to any directions of the Astronomer Royal, for the sum of £1,500, (£104,000 or \$166,400 today). His specifications covered a mere 2 ½ pages."⁶

** Airy's explanation of Dent's substitution for one of the maker's originally chosen seems purposefully vague. If Airy served in the same capacity of referee as he now proposes for the Westminster clock, he would have been intimately involved in such a decision.*

John Whitehurst sent his bid in September for £3,373, (£233,800 or \$374,000 today).⁶ Vulliamy, while never submitting a formal bid did have an internal figure of £3,500 plus £105 for the construction plans or £3,605 (£250,000 or \$400,000 today).⁷

Below are the original specifications as first laid down by Airy in June of 1846. My comments on these are in italics.

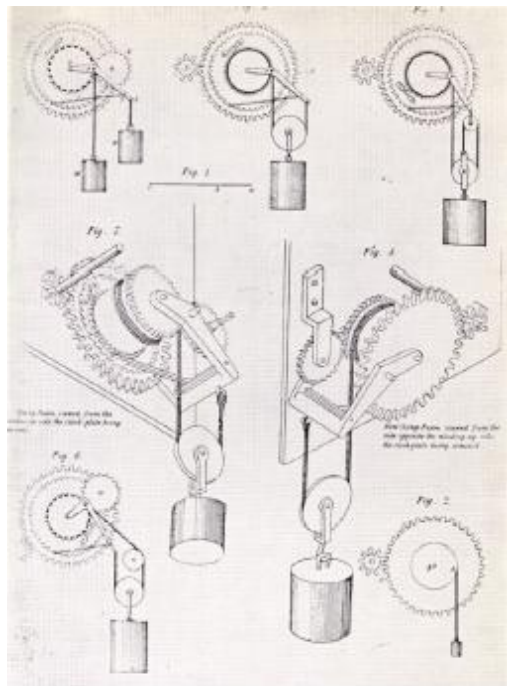

Airy's going fusee

1. The clock frame is to be of cast iron, and of ample strength. Its parts are to be firmly bolted together. Where there are broad bearing surfaces, these surfaces are to be planed.
2. The wheels are to be of hard bell metal, with steel spindles working in bell metal bearings, and proper holes for oiling the bearings. (*Wheel metal was later changed to cast iron, and a factor in the accident*)
3. The wheels are to be so arranged that any one can be taken out without disturbing the others.
4. The pendulum pallets are to be jeweled. (*This was later abandoned.*)
5. The escapement is to be deadbeat, or something equally accurate, the recoil escapement to be expressly excluded.
6. The pendulum is to be compensated.
7. The train of wheels is to have a remontoire action, so constructed as to not interfere with the deadbeat principal of the escapement. (*A train remontoire later abandoned.*)
8. The clock is to have a going fusee. (*A type of maintaining power, diagram above*)
9. It will be considered an advantage if the external minute hand has a discernable motion at certain definite seconds in time. (*Asking for a remontoire, as this device does this as part of its function? This is later abandoned along with the remontoire. Even so the remontoire would have needed a minimum of a 10 second cycle for it to be discernable from the street 184 feet below.*)
10. A spring apparatus is to be attached for accelerating the pendulum at pleasure during a few vibrations. (*This was a feature on the Royal Exchange clock but later abandoned here.*)
11. The striking machinery is to be so arranged that the first blow for each hour shall be accurate to a second of time. (*This was a major difficulty but achieved through Denison's design. Vulliamy argued until his death prior to the movement's completion that this could never be done with such a large mechanism.*)
12. The striking detent is to have such parts that it can make or break a magneto-electric current. (*This was later abandoned.*)
13. Apparatus shall be provided in order to make possible to convey the indications of the clock to several different places. (*i.e. to act as a master clock for slave clocks in the palace.*)
14. The plans are to be subject to the approval of the Astronomer Royal (*Airy, of course!*)
15. In regards to items 5 to 11, the maker is recommended to study the construction of the Royal Exchange clock. (*Dent's clock which Airy was familiar with and liked; calling it 'the best in the world.'*¹⁶)⁶

It is interesting that these specifications did not mention the size of bell to be struck or the number and diameter of the dials to be powered all of which would dramatically affect any design. Perhaps these specifications were considered common knowledge by this time.

On May 8, 1847 Airy submitted his report to the Commission on Vulliamy's bid. "It is impossible for me to consider Mr. Vulliamy as a person who can be employed to construct the clock, he having declined to compete, except before a numerous committee, and having objected personally to myself as a referee." He goes on to say, "I have carefully examined Mr. Vulliamy's beautiful plans. In regard to the provisions for strength, solidity, power, and general largeness of dimensions they are excellent. In regard to delicacy they fail; and they fail so much, that I think myself justified in saying that such a clock would be a village clock of very superior character, but would not have the accuracy of an astronomical clock." ⁸ This was the coup de grâce for Vulliamy and he never forgave Airy for his description of his design as a 'village clock' and from then on it was open warfare. In fact, Vulliamy's dislike of Airy was so intense; it was second only to his hatred of Dent, whom he regarded as a privileged and favored competitor - all of which was true!

A twist in the turn of events occurred in July of 1847. Dent had been promised in 1845, as an inducement for his unpaid work in the design and bidding for the Great Clock, the opportunity to also bid for all of the other hundreds of clocks that were to be installed in the palace. Vulliamy had been paid 100 Guineas up front for his bid; it is unknown if Whitehurst received any compensation. One can see how the profit from all of the palace clocks could easily surpass the difference of the £1500 between Dent's and his competitor's bids.

In the Spring of 1847, having received no invitations to bid on these other clocks, he made a number of inquiries and found that Barry was ordering all of these clocks directly from Vulliamy. He sent several letters complaining to the Commission and reminded them of their agreement. When this failed to illicit the desired effect, Dent took the drastic step of withdrawing his name from the job. He copied Mr. Airy who then contacted the Chief Commissioner. After a considerable internal battle, the Commission said that due to an oversight, Barry had never been told of the agreement that was made with Dent or the desirability of putting the work out to bid. After assurances that no more clocks would be ordered without Dent's ability to compete, he relented on August 20. Here again we do not know the exact truth. Barry may have simply gone behind the Commission ordering the clocks under the pretense that he had no knowledge of Dent's supposed participation. There was no question of Barry's partiality toward Vulliamy.

On August 17, 1847 the firm Thwaites and Reed, another large, English tower clock maker having heard of Dent's withdrawal, submitted a request to the Commission to be allowed to bid for the job. Airy, however intervened at this time with the Commission stating that it was too late in the process for them to enter and

that Dent was just reinstated to the bidding pool making this unnecessary. Thwaites, however, will cross the path of the clock again in a significant way much later on in its existence.



Edmund Beckett Denison

For the next couple of years nothing seemed to happen toward the final awarding of the contract for the clock. Here is where Edmund Beckett Denison, a well known and wealthy lawyer who was also an amateur horologist and architect, begins to play a major role. The term "amateur" is not used pejoratively but only to indicate that he did not have a formal training or degree in these fields. He was as proficient, at least in the case of horology, as any of his professional contemporaries. In May of 1848 he wrote to the First Commissioner complaining about the delays which had already occurred.

He virtually accused Barry of preventing the clock from being ordered because the Commission had previously prevented it from being placed with Vulliamy. This was unjust, as the delay was largely due to bureaucratic infighting and the large turnover of personnel that served on the Commission, although Barry did nothing to expedite the matter. It also boded ill for future relations with the architect. However, it did draw attention to the delays at the highest level and resulted in Denison being appointed joint referee with Airy on the bidding contest. This was a major step forward in the building of the clock because although Airy was a gifted scientist, he lacked the drive and determination that Denison could and did to push the clock to a reality. Denison was rather abrasive and never took into account the feelings of others and his brilliance which ensured that he was so often right in his opinions did little to make him popular with his contemporaries. Just take a look at his photo!

Denison took his responsibilities very seriously and immediately engaged in a full review of Dent's design; with many suggestions for improvements which virtually constituted a complete redesign.⁹ He was a gifted horologist and had designed some first class clocks and was considered a leading expert on the subject. He had contributed a section in Encyclopedia Britannica and his Rudimentary Treatise on Clocks, Watches and Bells, first published in 1850 became a standard reference work. This turned out to be a very good collaboration, with Denison's theoretical knowledge complementing Dent's practical experience and initiative.

After making a full examination of all three designs submitted, Denison wrote to the Commission stating flatly that Dent's design was superior to the other two; this of course after Denison had made this basically his own design! In addition he concluded the letter with the comment, "It is impossible not to feel that he [Dent] is under a disadvantage in having the architect opposed to him and evidently doing what he can to prevent him from being employed."¹⁰ Such comments in an official letter to the First Commissioner (which would have been brought to the attention of Barry) were to have a profound effect in steaming up the already difficult relationship between architect and clockmaker, whose close and friendly co-operation was so essential. It was to play a part in the redesign of the clock which was later to prove disastrous.

The uneven competition between Dent and the other contenders as orchestrated by Airy and Denison did not go unnoticed. Vulliamy had the backing of the Clockmaker's Company and was able to persuade friends in the House of Lords to initiate an inquiry in 1848. This inquiry entitled A Portion of the Papers Relating To The Great Clock for the New Palace At Westminster, printed by the House of Lords with remarks. It is a 56 page document that was restricted to private circulation within the House. The remarks are a scathing attack against Airy and Dent. But besides this contains a wealth of original correspondence between all of the parties and is recommended to anyone who would like to get a flavor of the contest as well as a wealth of minutia about the bidding process, specifications and bidder's data. Apparently nothing came of this inquiry and no action was taken by the House of Lords.

On January 29, 1852 the final changes in the specifications were submitted including the size of the hour bell to be 14 tons, each of the four dials 20 feet in diameter (later 23 feet), the wheels to be cast iron rather than bronze, the entire pendulum to be within the clock room necessitating the clock to be over 13 feet off the ground and requiring a stage or platform erected for winding the clock and examining it on both sides. The size of the bell and dials necessitated the clock to be of a larger size than first imagined. This cost partially offset by the change in wheel material from bronze to cast iron. Dent's final bid with these changes was £1800 (£149,000 or \$238,400 today), to be completed in two years.

By this time John Whitehurst had died, leaving Dent the only firm with a valid bid on hand. And so, on February 25, 1852 very nearly eight years after Vulliamy had been originally approached, Dent's bid was accepted. Judging from the other two contender's bids, Dent clearly was prepared to take a loss for the privilege of making this clock.

One must wonder what would have happened if Vulliamy had the sense to submit his specification and plans within a few months of the original request, and if he submitted his rough estimate of £3,600 instead of refusing to give the Commission any idea as to the cost. It might well have been accepted, in which case Dent, Airy and Denison would never have had such a golden opportunity to create, by their combined efforts, a clock which was to perform with an accuracy deemed by many to be impossible in so large a clock and which was to become the world's most famous public clock.

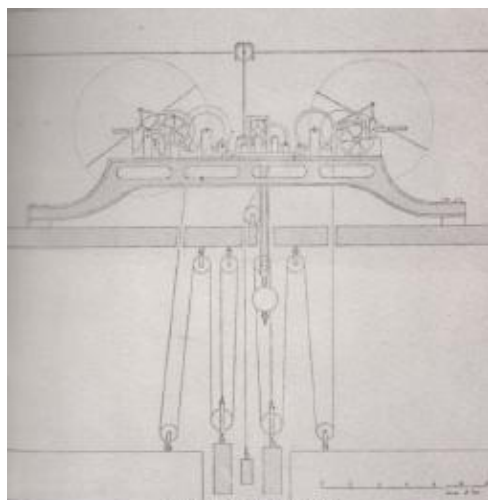

Vulliamy's design

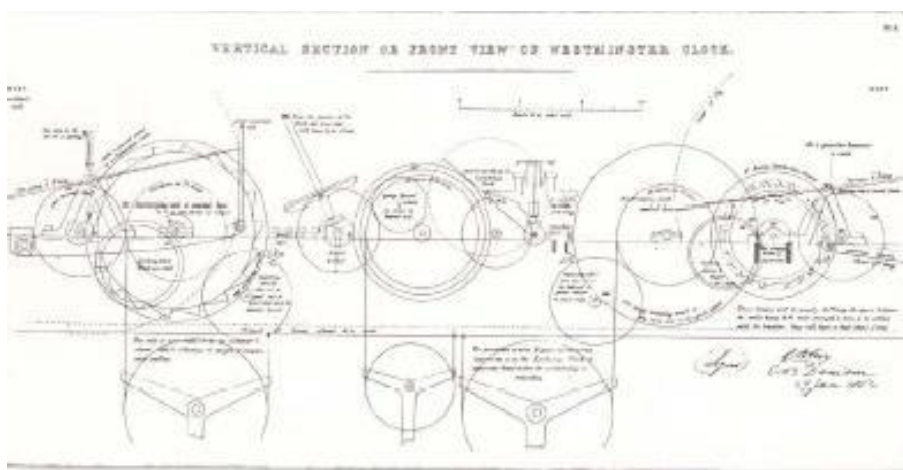

Dent's original design

Conflicts, construction and completion:

Dent had won the competition, such as it was, and now his problems were just beginning. The seeds of the clocks near destruction were sown in March of 1852 when an inspection of the tower was made. Remember now that the new palace had been under construction for several years. The first stone for the clock tower was laid September 28, 1843, nearly 8 ½ years earlier. At the time of inspection the walls were already up 150 feet of the total 316 feet. Dent was surprised to find that the interior dimensions of the tower would not accommodate his clock in its current configuration. They were built upon Barry's plan with Vulliamy's clock in mind. By April Airy, collaborating with Denison worked out adaptations to suit the current tower room's configuration and this added an additional £100 BPS to the cost (£8,300 or \$13,300 today). One change was the fact that the pendulum would no longer be able to be contained within the clock room but be hung through an opening below the floor. Most significantly was the fact that the wall facing the rear of the clock was too close to accommodate the space necessary for the huge hour and quarter chime fly fans. This mandated a change in the configuration of the fly fans and was the proximate cause of the accident that was to occur 124 years later.

This was not the only instance of conflict in the architect's design and the needs of the clock. To be fair it must be noted that the clock tower served not only the needs of the clock movement and its bells. It also was designed as part of a ventilator shaft system that connected to another 300 foot tower in the center of the courtyard designed to take air from the Lords and Commons chambers, also known as the tower of St. Stephen's. There were also rooms that were to ring the central core as well as a staircase to ascend the full



St. Stephen's tower

tower's height. The central shaft or core of the tower was 11 x 8 feet and here is where the weights would descend. This was also the way that the bells and the clock mechanism would be brought up the tower.

Barry had specified as early as 1842 a bell of 14 tons to strike the hour. Although no bell this large had yet been cast in Britain, it required only a simple calculation from the proportions of normal bells to see that a 14 ton bell of conventional design would need a much larger shaft. In 1855 Denison had redesigned the great bell to be shorter and wider than that of conventional shape. In this way it could be hauled up the tower lying sideways in a cradle. In October of 1858 the bells were raised into position.

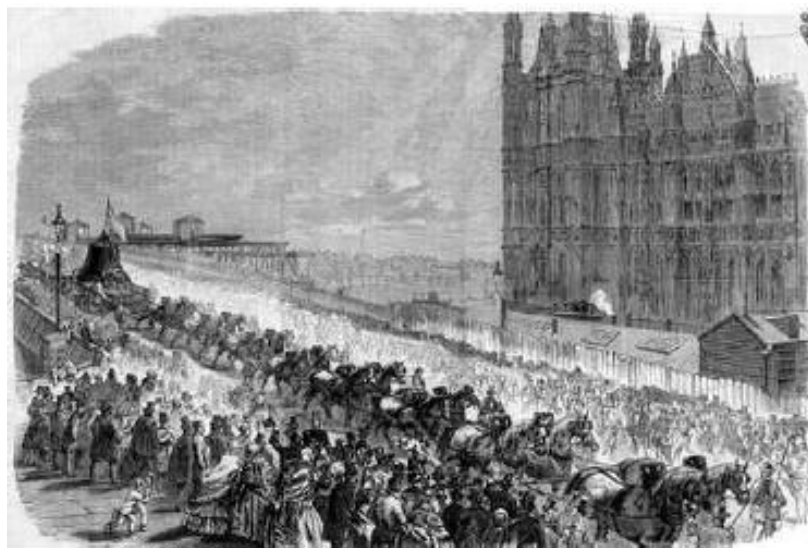

Public procession for bell installation into north tower



Big Ben bell on cradle being put into tower base

Dent began work on the clock soon after he won the contract in early 1852. The clock took his firm two years to build and was completed in late 1854. Edward Dent died in March 1853, and so Frederick Dent, Edward's step son, who had been left this part of the business continued with the production of the clock. The frame measured 15' 4" long and 4' 11" wide with the mechanism weighing in at 5 tons. Upon completion came factory trials which were conducted by the staff of the Royal Observatory under the supervision of Airy and Denison and lasted over half a year. In 1855 the Astronomer Royal had notified the Chief Commissioner of his complete satisfaction with the mechanism and recommended that Dent be paid his fee.

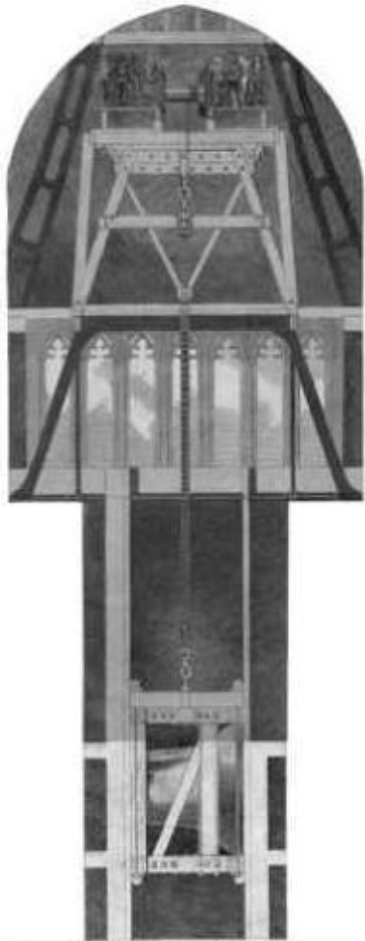

Big Ben bell being lifted up tower

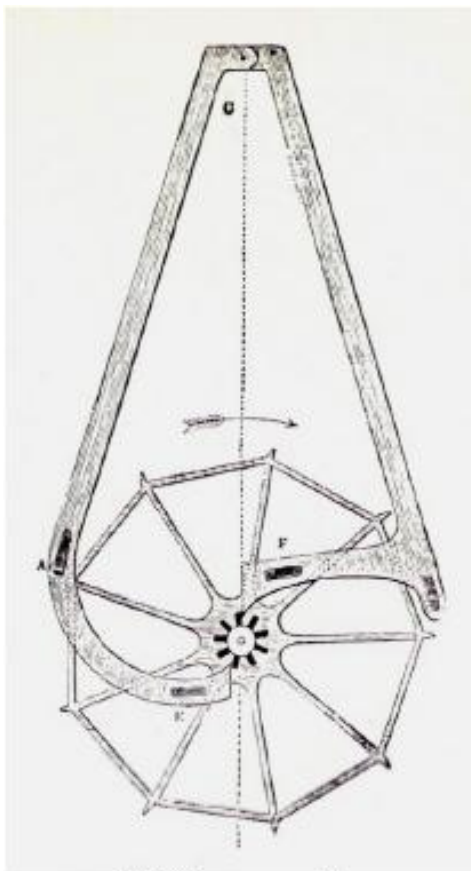

J.M. Bloxam gravity

The development of the gravity escapement:

At this time the tower was still only half way completed even though it had been started some 12 years earlier. This proved to be a blessing in disguise as it allowed Denison, who was never satisfied even with his best efforts, to carry out many refinements in order to improve the accuracy of the clock. While the mechanism had met the entire criterion established in the Astronomer Royal's specifications, Denison was concerned with how stable the escapement would be when exposed to the realities of driving the four heavy dial hands in adverse weather conditions. As a result he began experimenting with gravity escapements.

Gravity escapements are distinguished from conventional escapements since the impulse is not given to the pendulum directly by energy from the main weight through the clockwork, but by some other small weight lifted up, or small spring bent, always through the same distance, by the clock train at every beat of the pendulum. This gives a constant impulse to the pendulum regardless of other variables the train is subject to. Many illustrious makers had tried to perfect the gravity escapement - Berthoud, Mudge, Cumming, Reid and Hardy. Bloxam had come close in 1853. All of these prior attempts suffered from various problems, chief amongst them the fact that the pallets had tended to bounce off the escapement locking surface; known as 'tripping'. Denison had begun thinking of an improved gravity escapement in 1846. His first actual attempt at a new escapement design was the three legged dead beat escapement. He conceived of this escapement in 1851 and it was applied to the pendulum for six months.

Probably in conjunction with a spring type remontoire to prevent variations of force from the rest of the wheel train, and in the arc of the pendulum (see below).¹¹ This was then improved, but it is not known if it ever was applied to the clock. On November 27, 1852 Denison wrote to Airy describing his three-legged gravity escapement. This contains all the elements of the classic gravity escapement, the remontoire action of a constant impulse power supply and Denison's all important innovation of the inertial fly fan mounted to the escapement arbor via a slip clutch thus solving the tripping problem. (See appendix).

He then developed a four legged version and this was a considerable improvement over the prior one in that the arc of travel was 1/4 revolution verses 1/3 increasing efficiency and lessening impact of the legs on the pallets. It was this escapement that likely was installed into the clock when it was first started in the tower in 1859. His final design, the double three legged gravity, also known as the six legged, was his last improvement to the gravity escapement in 1860.¹²

It replaced the prior 4 legged escapement and controls the time train to this day. The importance of his innovation of the fly fan mounted to a friction clutch cannot be overstated. It allows the fan to advance slightly after the escapement engages the pallet. The inertia provided by the weight of the fly keeps the escapement seated against the pallet during locking; in essence acting as an 'energy sink'.¹³

This escapement provides a nearly detached pendulum from the rest of the clockwork and is particularly important in tower clocks where wind and weather can cause disruptions to the movement through the exterior hands. Another special feature of this escapement is that there is no sliding friction on impulse so it does not need oil. Again, due to the environment in which tower clocks are found oil contamination is a problem; severe temperature changes can cause oil to thicken and thin beyond their normal intended

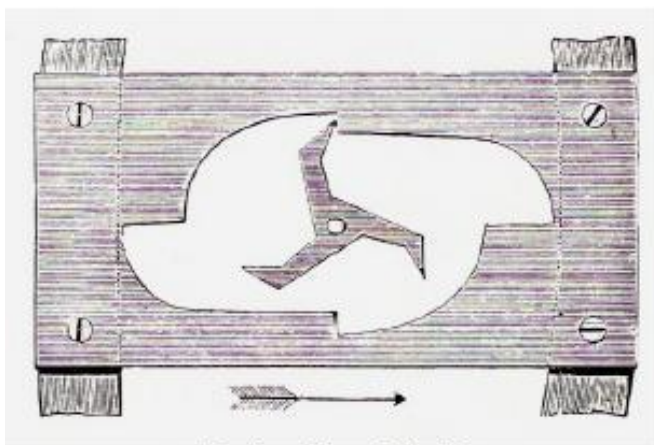

Denison 3 legged dead beat

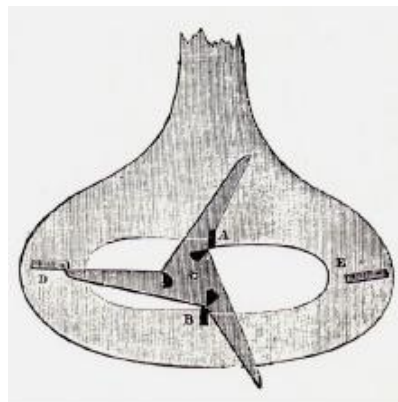

Denison 3 legged dead beat, improved

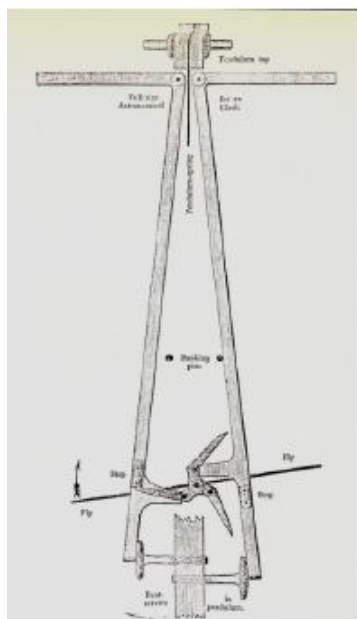

Denison 3 legged gravity

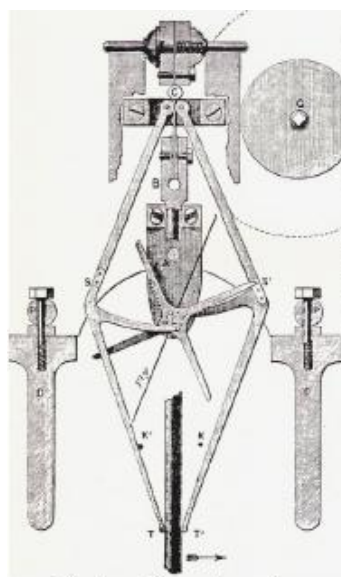

Denison 4 legged gravity

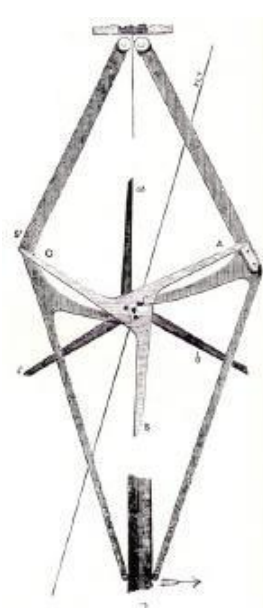

Denison 6 legged gravity

characteristics thus affecting the escapement. This design belongs to a family of escapements known as *escapement remontoire*. Conventional train and spring remontoire had been installed on clocks prior to this to achieve the same function. It is not known for certain if the movement was originally equipped with a remontoire. Airy's original specifications seem to call for one, in which case it probably would have been be Airy's design (diagram right) and would have been considered essential for such a high profile clock especially as it was first conceived and tested with a conventional Graham and pinwheel deadbeat escapement which would have benefitted from such a device. If one was present, the gravity escapement made it superfluous and so it was removed.

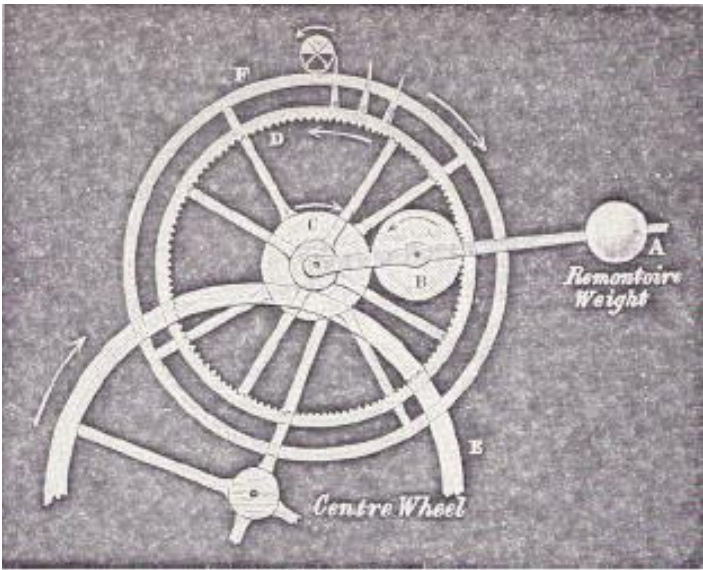

Airy's train remontoire

So important was this invention that the gravity escapement is considered one of the great advances in the science of horology; it was soon adopted as the standard for the best tower clocks, as well as domestic clocks where there was a need for exceptional accuracy as in observatories or time standard master clocks. While much has been written about Denison's difficult personality - he did not suffer fools lightly, and it seems he viewed many of his compatriots in this category. Nonetheless, he did not choose to patent his new escapement. He was a lawyer, and knew full well the economic benefit that would accrue to him from such a patent. His sole interest was to allow this escapement to become as economically practicable as possible and so be able to advance the science of horology as a whole.

Now the movement was complete and as perfect as Dent and Denison could make it. The tower was topped out in and the bells were installed 1858. The dials, motion works and connecting shafts were begun in 1859. It is a tribute to Denison that the Commission and Astronomer Royal allowed this new escapement to be fitted to this national symbol of pride without any rigorous trials - there could not be any, as the escapement was being developed just prior to the clock being assembled into the tower; with the last escapement being fitted about a year after the official starting of the clock on May 30, 1859. The final cost of the clock was £2376 (£174,000 or \$278,000 today). In comparison the dials and hands cost £5534 (£405,000 or \$648,000 today) and the bells £5960 (£436,000 or \$698,000 today).¹⁴ The fact that the bells were the most expensive component is common with large and/ or numerous bells. Bell casting is a laborious, difficult art involving expensive metals of copper and tin. As noted earlier, a successful casting is not guaranteed and re-casting is at the bell founder's expense.

The final cost of the New Westminster palace came in at three times the original estimate or £3 million (£220 million or \$352 million today). It's nice to know some things never change! These figures, as do all prior comparisons, use the retail price index. In this case the average earnings index may be more appropriate considering the huge amount of hand labor that was involved in the construction. Using this index the cost was £19.5 billion or \$31 billion. To replace the palace today is probably somewhere in between these two indexes at about £10 billion or \$16 billion).^{7, 14}

The seeds of destruction:

The clock was made and tested as best as Dent's firm was capable. But what was not tested; indeed could not be tested with the science available at the time, was the redesign of the mechanism's huge strike train governors, its fly fan system. The problem of the clock movement's fit into the tower would require a compromise in the design of this system.

The diagram below shows the front elevation of the tower as originally designed by Barry, the next two a first floor and clock room floor cross sections as currently built. The central core where the clock weights must descend is located in the center of the structure measuring approximately 11' x 8'. The clock must be centered upon this opening not only for the weight lines but for the fact that this is the geographic center between the four dials making the linkages to clock faces most efficient. Notice adjacent to the core is another two unmovable structures, the ventilation shaft to the right (now no longer in use) and the staircase on the left. If we call that area the 'rear' of the room we see that a clock with a conventional design that have horizontally

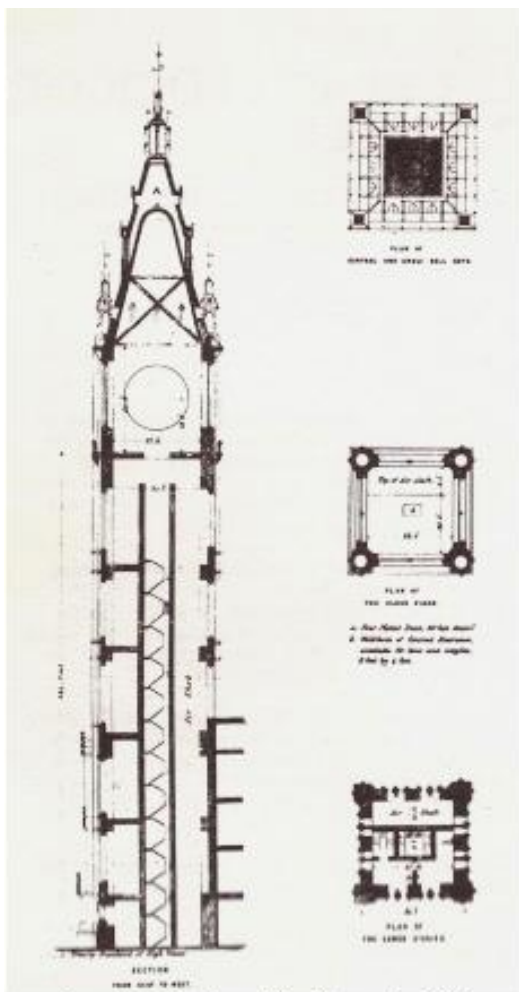

Tower as designed by Barry in 1847

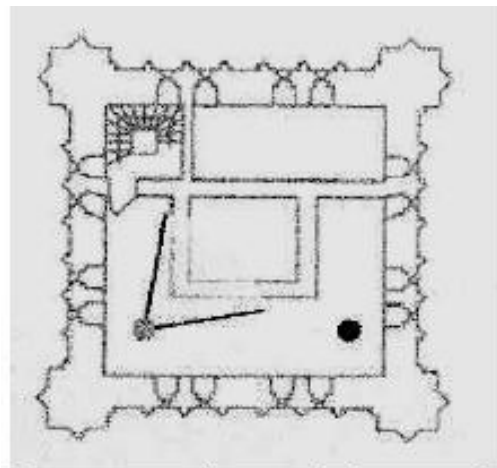

Tower cross section up to clock room, today

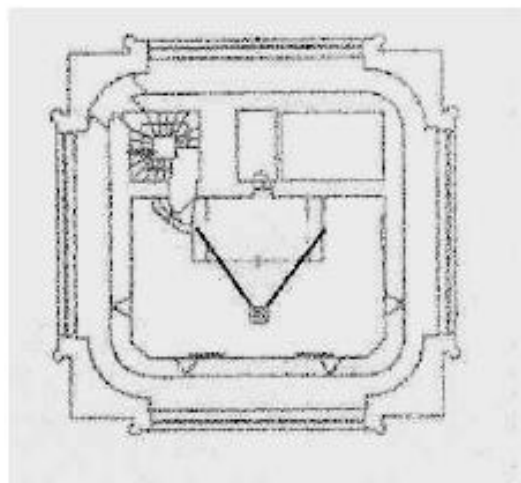

Tower cross section, clock room, today

mounted fly arbors originating from the rear of the clock would be impossible. It was also necessary for workman to be able to access the mechanism from all sides for the purposes of servicing. Putting the flies on the two ends of the clock would block access from each of the two sides. The flies could not be located in the front since winding took place from this point and these would endanger the workman. From 1859 through 1913 the clock was wound by hand. It took two men employed for five hours per day, three days a week (the strike trains could go just over three days; time train for 5 days). Since the clock chimes every 15 minutes this

would have been an impossible situation. Most conventional tower clocks are designed to go for eight days. It's possible that the time train as initially designed with a conventional deadbeat escapement would go this long. A gravity escapement with four or six legs will turn from 5 to 7.5 times as fast as compared to a conventional escape wheel with 30 teeth; significantly cutting down on duration. For the strike trains to go eight days, the weights would need to be nearly three times as heavy. The weights for the hour, time and quarter trains are 1 ton, 560 lb and 1 ¼ ton. An eight day duration would have added another 6 tons; far exceeding the design strength of the over 15 foot free-span movement frame. Vulliamy's design called for an eight day duration on all trains.¹⁵

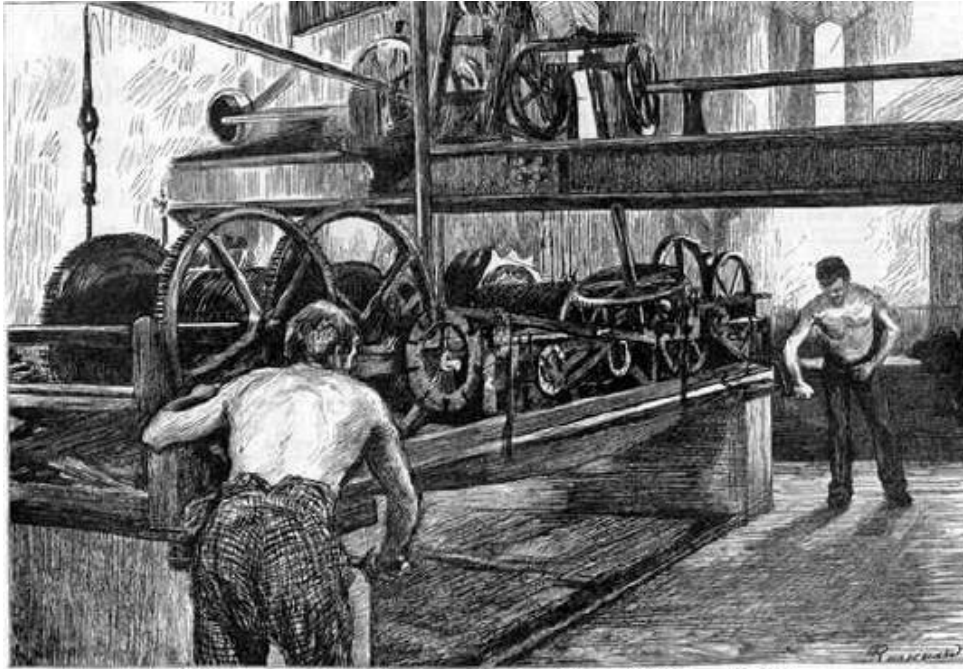

Movement strike trains manually wound from 1859 through 1913

As a side note the time train is still wound manually to this day once every four days with the strike trains wound automatically by an electric motor. Before this, as stated previously, two to three men spent between five to six hours every three days to wind the mechanism. Although the winding handles were attached to a reduction gear set, they were still very heavy to turn and needed 100 turns of the handle to turn the great wheel drum with its one or more ton of weight one turn.

Not only this, but there was no maintaining power on these trains, so winding had to be interrupted during striking. Imagine having wound the crank handle a hundred times only to see 25 turns unwound in the fourth quarter chime strike sequence! No wonder it took nearly all day to wind.

The lack of room or practicality for the flies on any quadrant of the clock mechanism's frame leaves only one place to go and that is up. The diagrams next page show the original design by Dent's firm as well as the redesign to allow for the fly fans to be raised high above the movement. That also obviated one of Airy's early specifications that the entire 13 foot, pendulum be contained within the room. With the flies above the movement, this could not be done. Instead a section of the original air shaft had to be impinged upon at the clock room level and one level below to make way for the pendulum (right diagram).

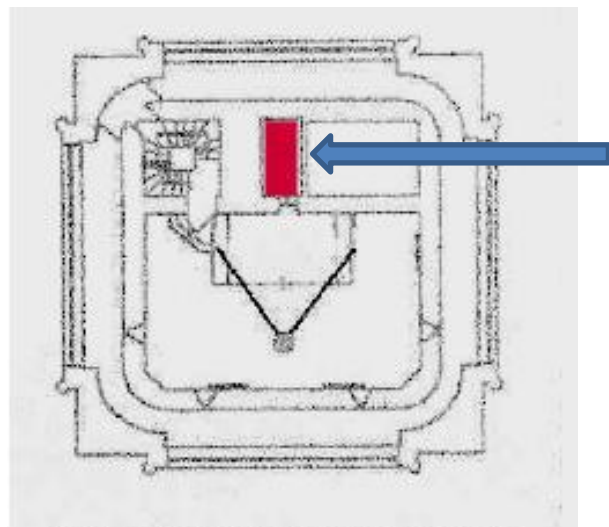

Area reserved for pendulum in air shaft

The long tubes would have been fabricated from flat iron strips which would have been formed into U-sections, drawn through a circular die at red heat and finally the butt joint hammered to form the welded seam. Unfortunately the method of making seamless tubes was not developed until after the construction of the clock.¹⁶

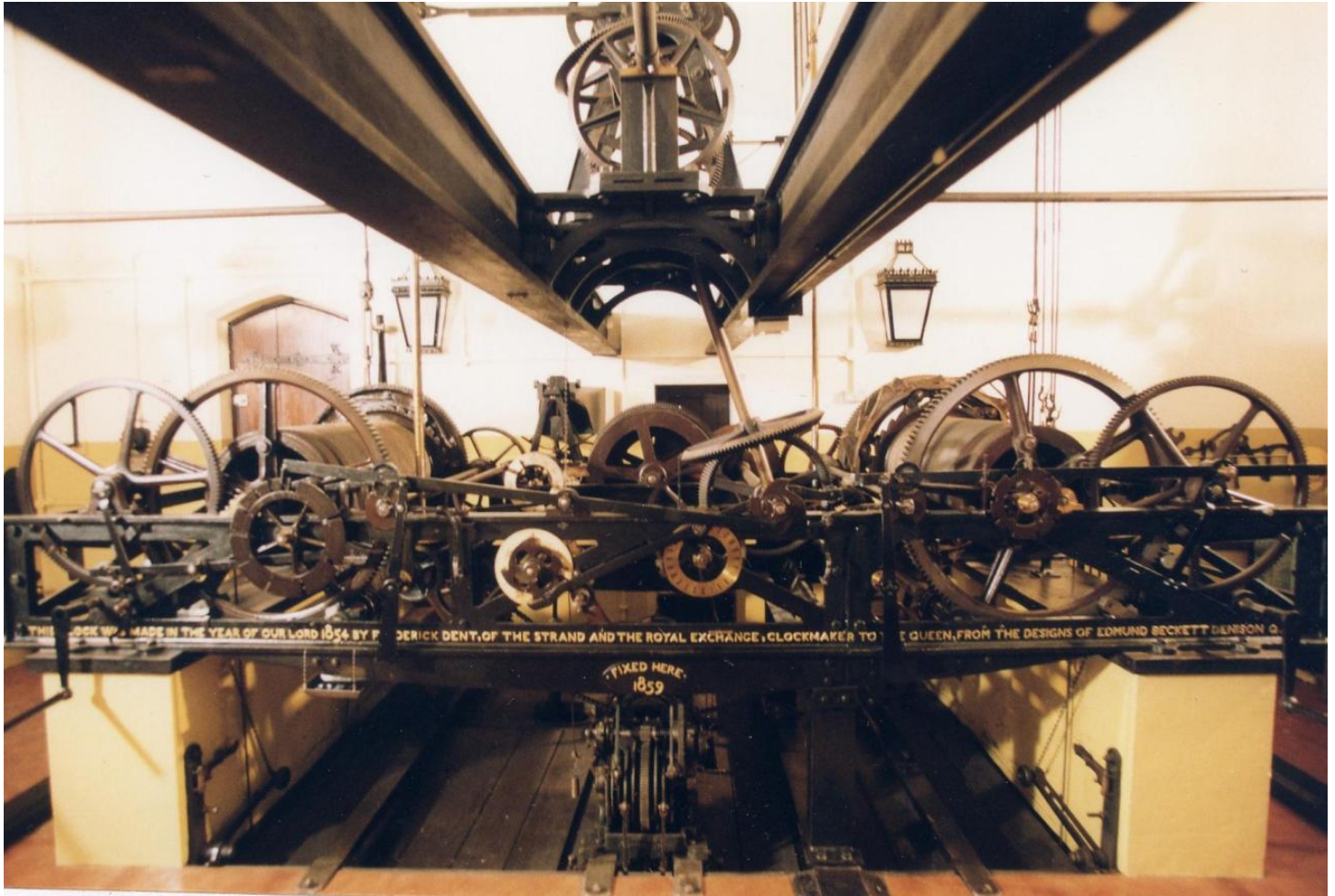

Movement as seen today

The accident:

Most of the information and photographs presented below are excerpts taken from a booklet containing compiled reports documenting the accident as well as the later forensic analysis of the movement components and events leading to the accident. These were issued by the Engineering Sciences Division of the Institution of Mechanical Engineers and The National Physics Laboratory of England, pages B1, B4-B9. My comments are in italics.

On August 5, 1976 during the 3:30 AM chime sequence, the wrought iron tubular shaft of the fly governor, controlling the operating speed of the quarter chiming mechanism, failed by metal fatigue. This allowed the 1 1/4 ton driving weight to fall uncontrolled for 40 m (132 ft) to ground level, thus forcing the chiming mechanism to operate at a speed far in excess of its design limits. This caused the disintegration of the mechanism and broke the cast iron frame of the clock. The winding drum (3/4 ton) of the chiming train was torn loose from its bearings and both it and parts of the cast and wrought iron mechanism had been flung around the clock room with some smaller pieces (up to 5 inches) being projected through the ceiling into the room above. *It was fortuitous the accident occurred in the early morning hours when the room was unoccupied; if anyone had been present it is likely they would have been killed. The clock room is*

unconventional in that the clock is housed in an inner room with walls made of solid masonry. Surrounding this is the exterior tower wall in which the dials are mounted. These walls are separated by a 5 foot wide passage space. Had the clock room been of conventional design with no inner solid wall and with the four 23 foot glass dials surrounding the clock, the ¾ ton chime barrel could have been propelled through a glass dial and down 184 feet to the ground.

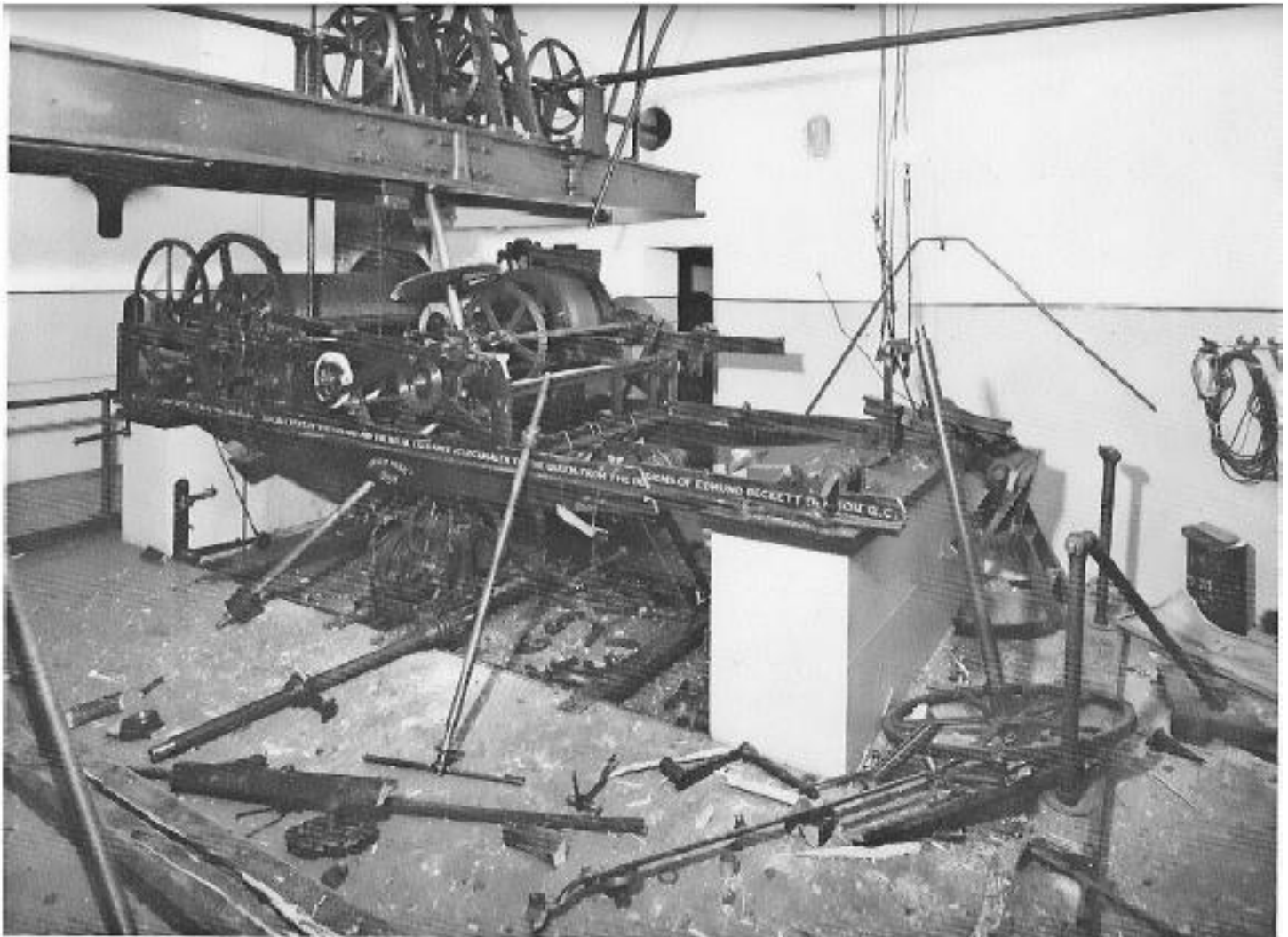

Photo 1. Chime train and frame stripped away. Count wheel attached to its frame and laying in the foreground.

Notice in the first post event photo, above, the section of the top frame rail with the quarter count wheel (known as a locking plate in England) still attached laying in the foreground. The lower main frame front member with the dedication inscription is broken about one-third of the way from the right end of the damaged chime area. The main frame was broken in five places. At the top, middle portion of the photo one can just see the fly fan drive tube hanging next to the motion works lead off support girder. In the photo next page, this is more apparent as the fly itself is partially supported by the remaining fly steady which is attached to the upper girder with the balance of the fly entangled on the lead off wheel nest. The next page shows two other angles of the movement as well as views of where the chime barrel came to rest.

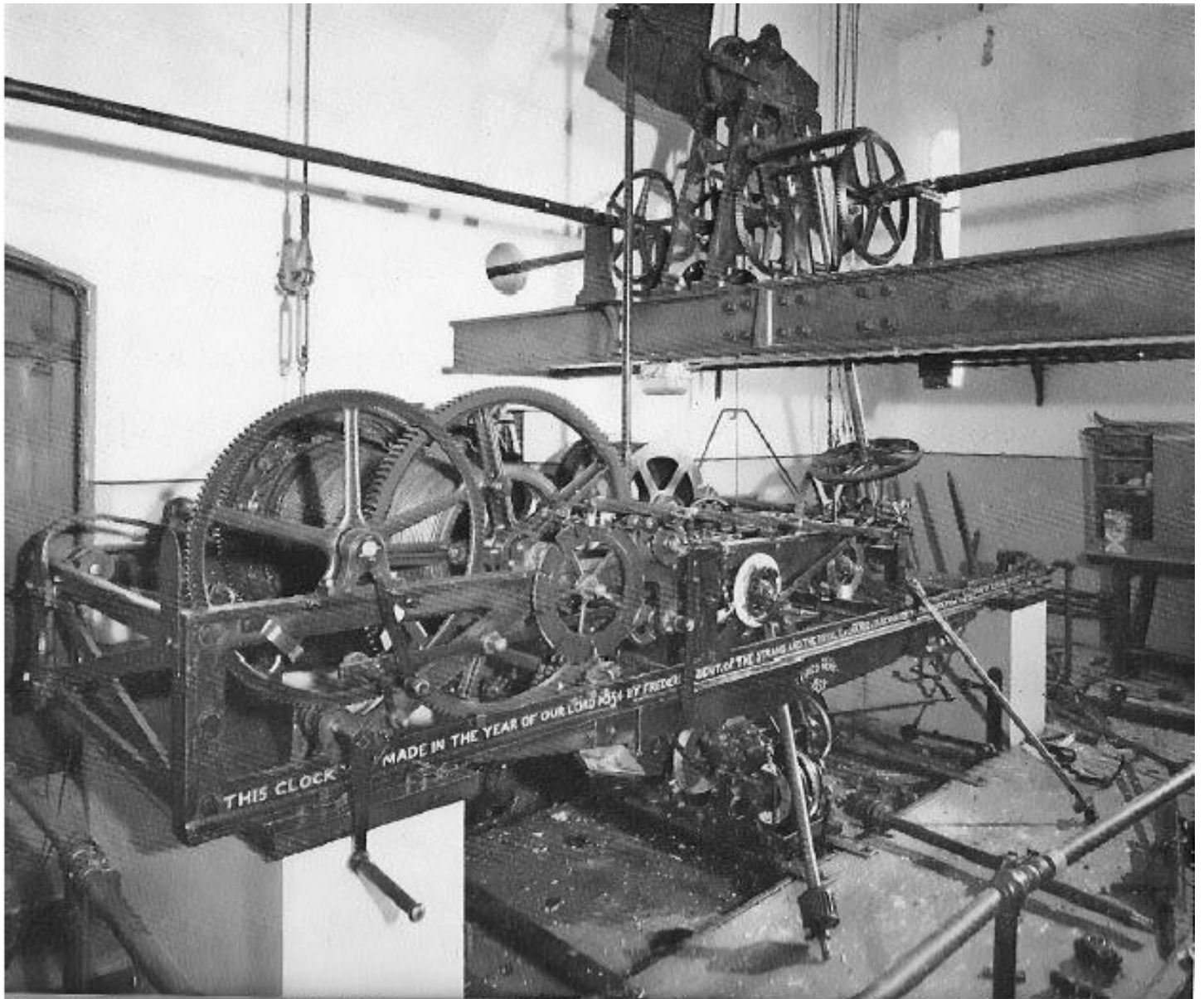

Photo 2. Three-quarter view left side. Damaged fly is left hanging on its steady; entangled on the lead-off wheel nest.

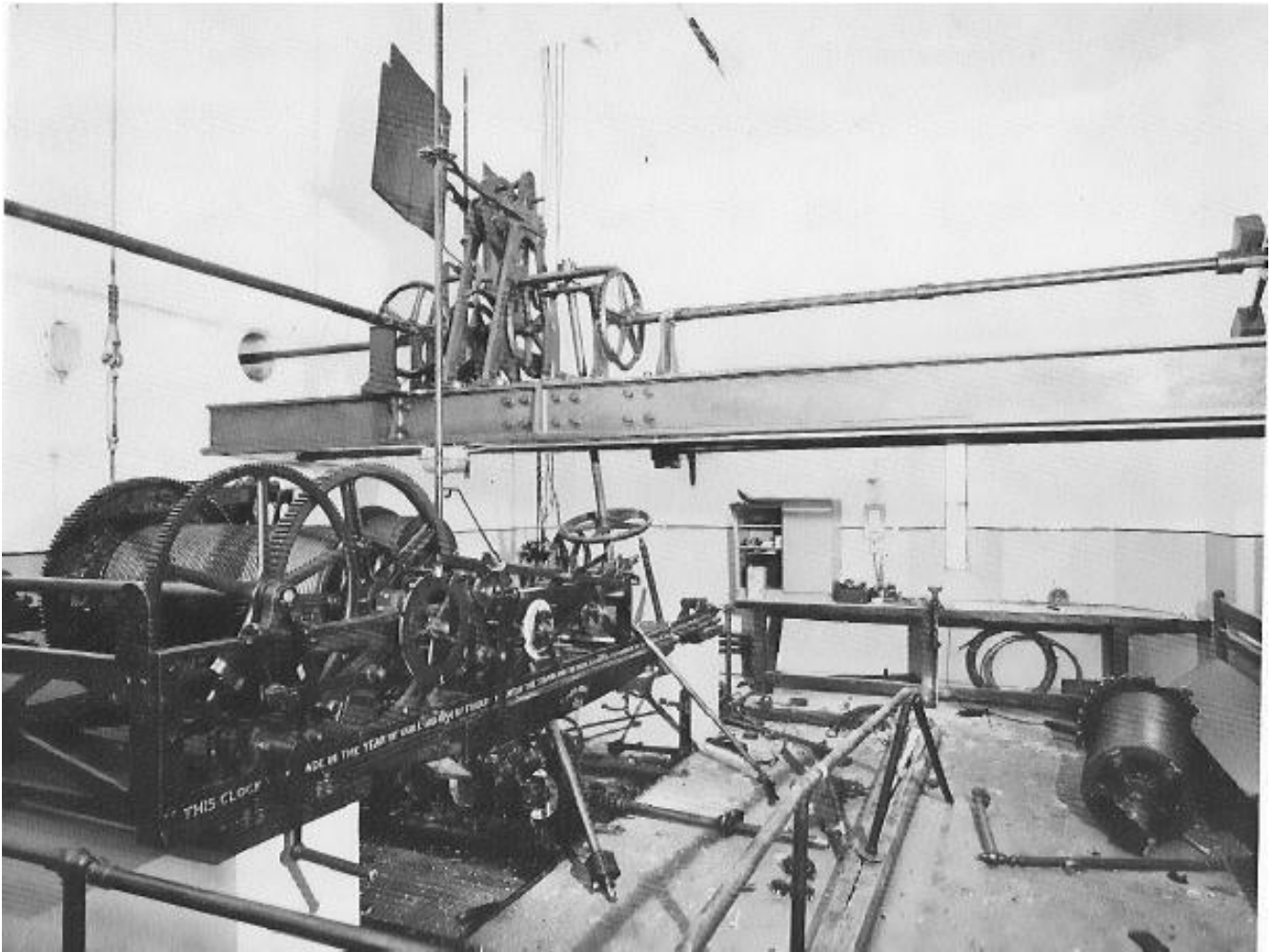

Photo 3. Strike side view and showing where $\frac{1}{4}$ ton chime barrel came to rest.

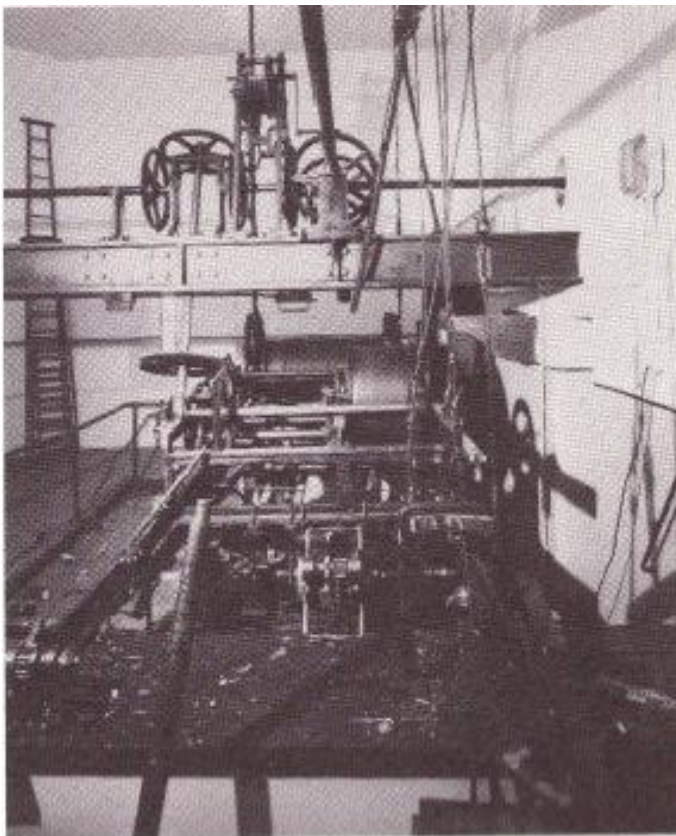

Photo 4. End view from chime side



Photo 5. Note chime main wheel to the left

The official report continues:

Tube schematic, (Fig 1).

A crack had initiated, probably in the lower end of the tube, which developed into a fatigue crack. This propagated for 1 m (40 in) along the tube, at which stage transverse cracks developed; these extended halfway around the circumference of the tube before secondary helical and longitudinal fractures developed during the final stages of the tube failure.

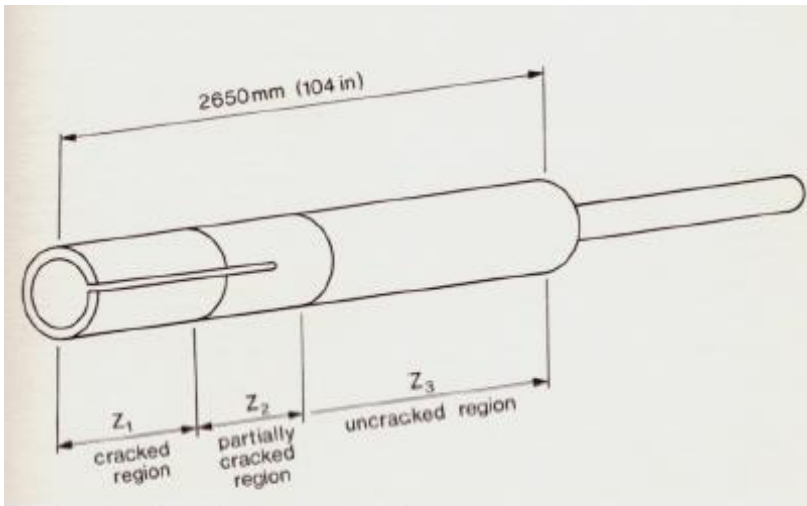

Fig. 1. Tube schematic showing main fracture.

Lower half of the broken tube and its bevel, (Fig 2).

The pipe clamp was installed in the 1956 overhaul to keep the bevel wheel arbor from slipping within the tube. The fly governor is a critical part of the chiming mechanism since the fly acts an air brake to control the rate of chiming, and hence the speed of the mechanism. There was extensive fatigue cracking in the wrought iron tube component of the vertical shaft. The main fatigue crack (a), which followed weld seam along the length of the tube, extended approximately 40 inches from the lower end of the tube where it was attached to its driving bevel gear wheel. Because it was masked by the welded seam, and because the outside of the tube was a dark grey color covered in parts with a black oxide scale, the crack was not easily discernable, apart from the first few inches at the lower end, marked 'Crack A'.

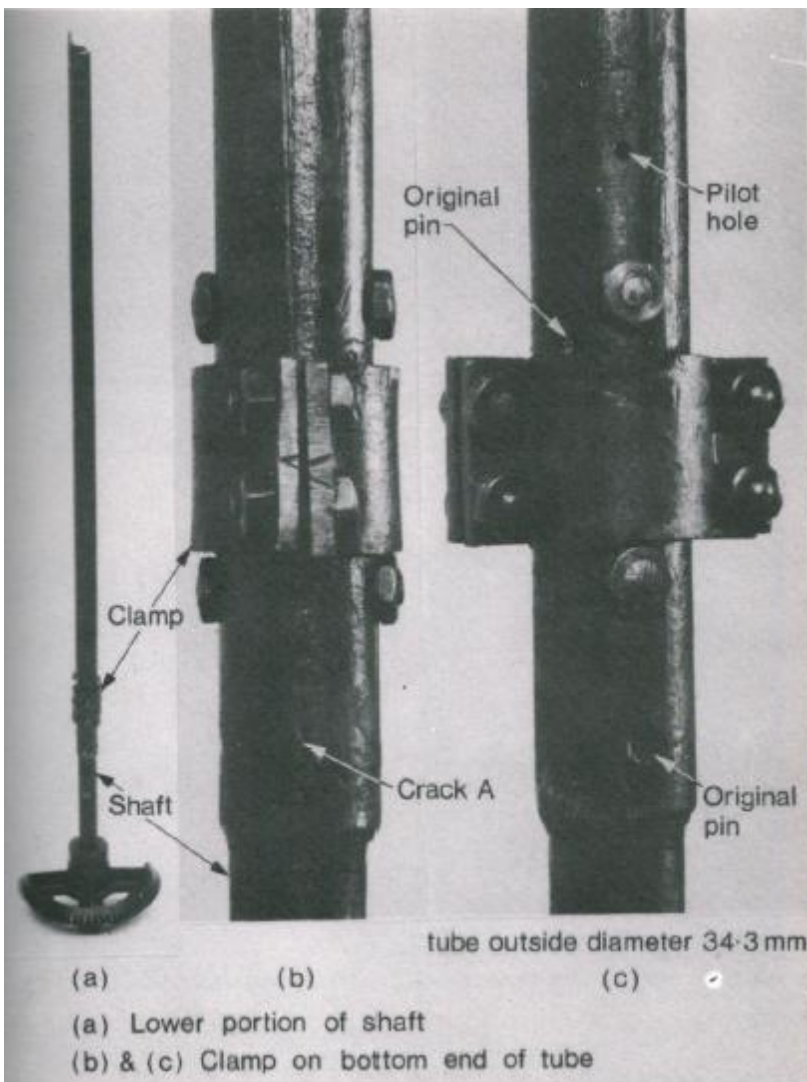

Fig. 2. Chime drive shaft with damaged bevel drive wheel.

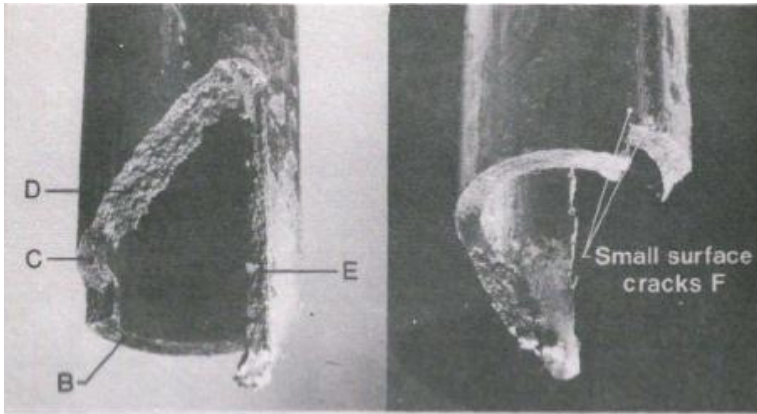

Fig. 3a. Upper chime tube fracture area.

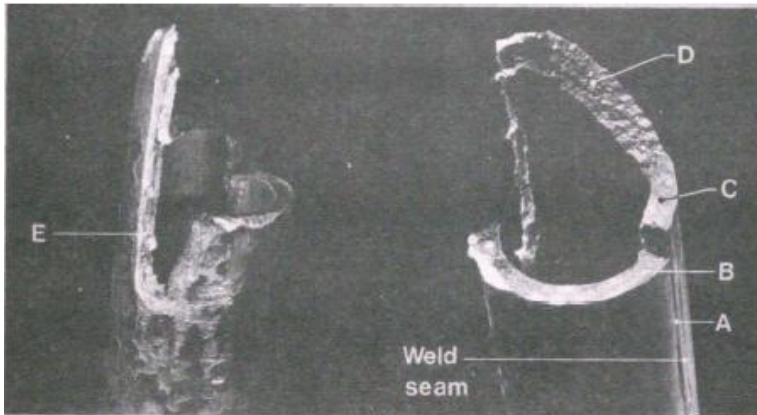

Fig. 3b. Lower chime tube fracture area.

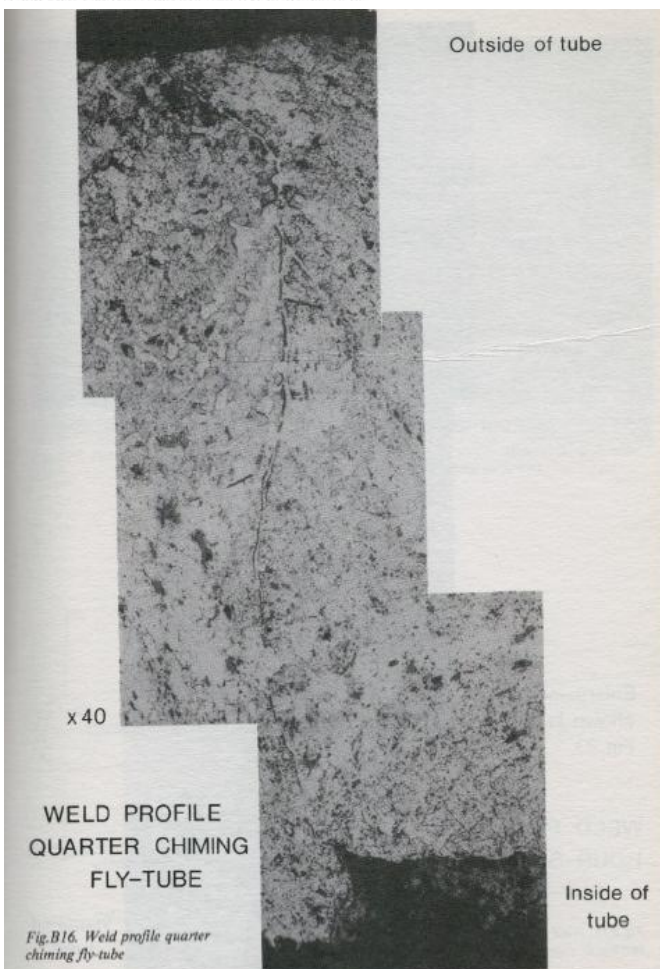

Fig. 3c. Cross section of chime tube butt weld at 40x magnification.

Broken ends of the chime tube, upper portion, (Fig 3a) and lower, (Fig 3b).

Circumferential fatigue cracks had developed near the leading end of the longitudinal crack marked A, and the two which lead to the failure of the fly shaft are marked B and C. These cracks which were initially approximately perpendicular to the axis of the tube, changed to a helical mode with that at D running 45o to the tube axis. The region of final failure was manifest

by its brighter appearance and its rough and deformed surface, marked at E. Tube outside diameter is 34.3 mm (1 3/4 inches).

Weld Profile of Quarter chiming fly tube at 40x magnification, (Fig 3c).

A macrograph of the weld region in the upper portion of the tube 100mm (4 inches) above the circumferential crack marked C (*Fig 3a*) is shown below, from which the fibrous and laminar nature of the material is apparent. The flow lines indicate that a form of butt weld was made, and a bulge marking the junction where the two ends of the joint were forced together is evident, especially on the inside of the tube. The area shows the presence of a stress raising notch at the inner surface of the tube.

This was filled with slag and was probably formed during the welding process when the surface material on one side of the joint was forced to flow past that on the other side. The root of the notch lay along the line of the weld, which can be clearly seen in *Fig. 3c*. The weld line was marked by a region of differing etching characteristics, probably caused by higher concentrations of oxygen and other impurities at the weld. The weld joint coincided with a plane of maximum shear stress, and as seen in the photo above, the crack followed the line of the weld across the tube wall, joining the notch at the inner surface to a similar notch (though less evident) at the outer surface of the tube.

So examination of the chime fly tube shows that the way the tube was manufactured, using a butt welded seam, and to a lesser extent some manufacturing and materials quality control issues, directly contributed to the failure. It was an unfortunate coincidence that the maximum shear stress for the butt weld would be present along its weakest, which is longitudinal, profile. To be fair, this was before the advent of seamless tube manufacture. In addition this type of tubing was generally used in water and gas piping which would not present the types of shear stresses to the butt weld seam. In this application the tube was called upon to perform structural duties for which it was not suited. The presence of the weld seam, through which the crack had progressed masked the crack which may have, in the absence of such camouflage been discovered prior to the accident.

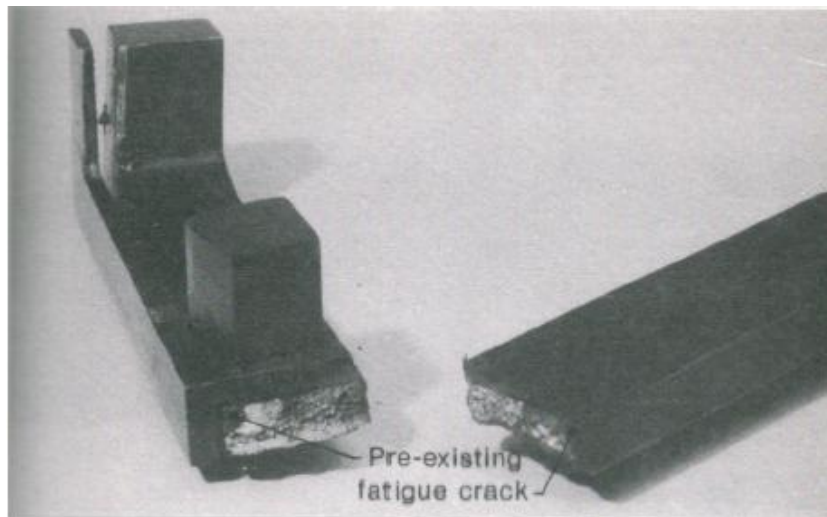

Fig. 4a. Chime locking lever, fractured end piece.

Chime locking lever end piece, (fig. 4a) and the overall component, (Fig 4b).

The head of the wrought iron locking lever was broken off. The main fracture appeared to be caused by impact but the fractured faces contained a zone of fatigue damage which no doubt existed prior to the final failure, (Fig 4a). The tail of the locking lever was bent and damaged locally from impact, and its drive shaft bent at the lever end, (Fig 4b).



Fig. 4b. Chime locking lever, overall view showing bent counter-balance tail.

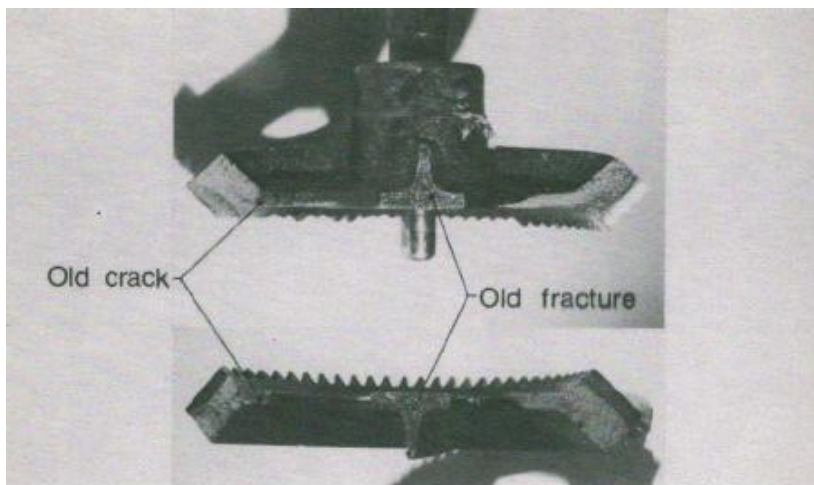

Fig. 5a. Chime fly shaft bevel showing pre-existing damage.

Chime fly shaft bevel, (Fig. 5a and 5b, next page),

There was an old fracture in one of the four spokes of the cast iron bevel wheel on the fly shaft, (Fig 5a) and one other spoke also contained an old crack. The teeth on the fly shaft bevel were damaged consistent with that expected from the mating gear wheel on the drive shaft if it were partially engaged, (Fig 5b).

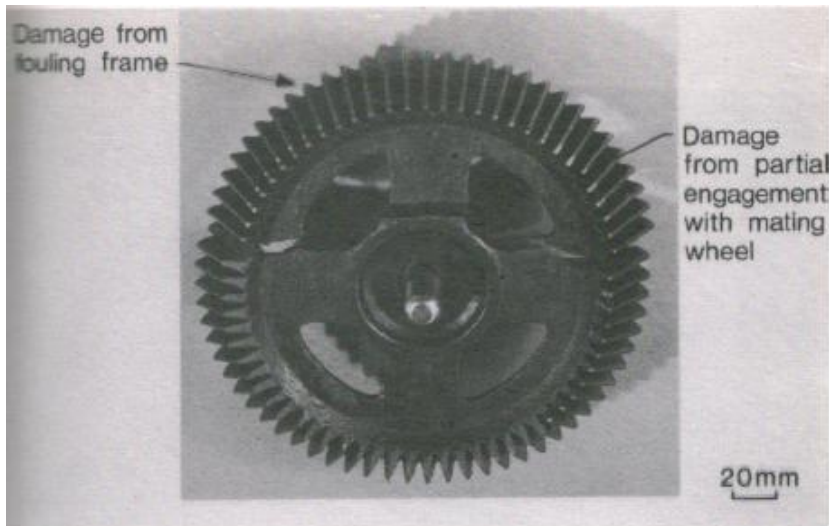

Fig. 5b. Chime fly shaft bevel reconstructed showing tooth damage from partial engagement.

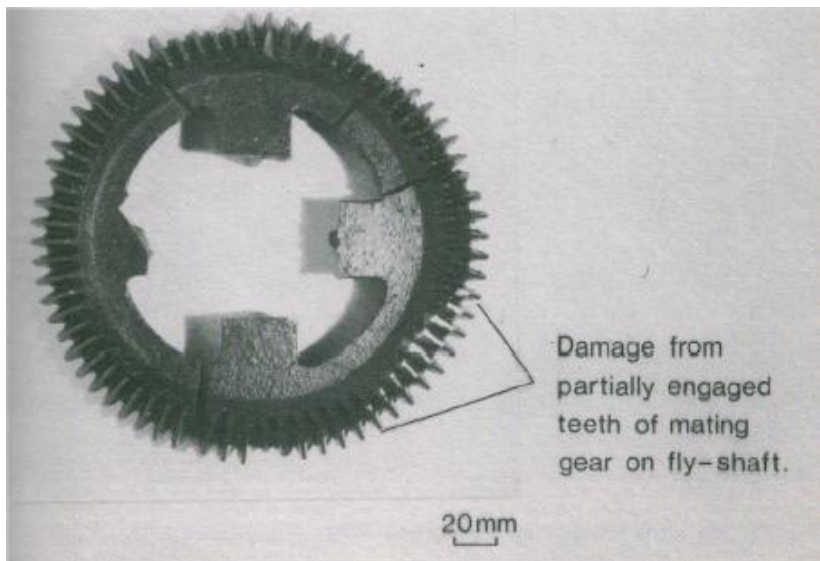

Fig. 6. Chime drive shaft bevel showing tooth damage from partial engagement.

Chime drive shaft bevel, (Fig. 6).

The damage to several of the drive shaft bevel wheel teeth was consistent with that expected from the mating gear wheel on the fly shaft if it were partially engaged, (Fig 6).

There was also evidence of an old repair, by welding, at a break in what was thought to be a piece of cross bracing of the cast iron frame. *An old repair was a location of weakness and was one of the five locations of where the frame section ruptured.*

The bearings for the locking lever and fly drive shaft, which shaft was bent at one end, were mounted in cantilever brackets integral with the cast iron clock frame. These brackets were open at the end to enable the shaft assembly to be mounted as a unit in the clock frame. The fork end of both brackets had been snapped off at their minimum section across the bearing diameter, and the fracture surfaces were all indicative of brittle failure. The minimum section of the fork end of the bracket nearer the fly shaft gearing had been reduced further by the addition of two holes tapped for screws to retain the bearing, and the plane of the fracture ran across this reduced section through the centers of the holes, (Fig. 10).

The appearance of the remaining fractures observed in the broken cast iron frame and other components was consistent with that associated with impact loading. *In other words breakage due to forces beyond the frame's and other components design limits.*

So now we have a picture of the main components that failed in the first moments of the accident. All of these critical components had pre-existing damage in the form of metal fatigue fractures in addition to the damages suffered in the accident.

Probable sequence of failure events:

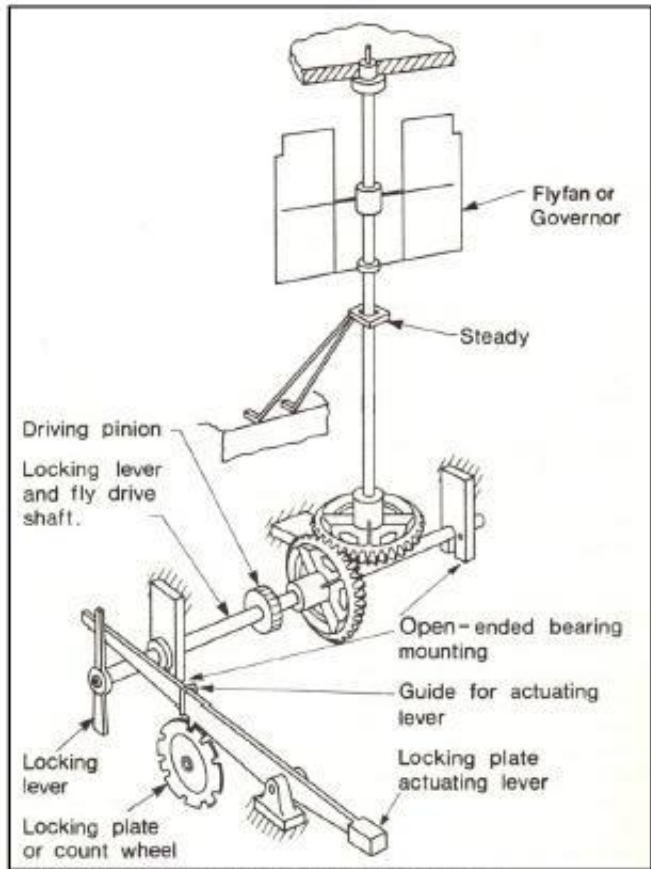

Fig. 7. Fly governor mechanism pre-damage.

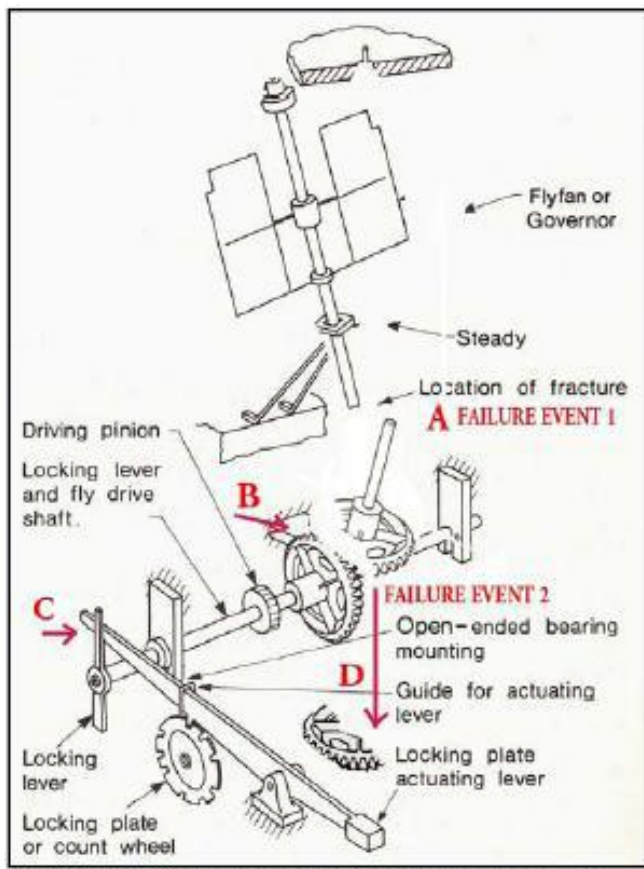

Fig. 8. Fly governor mechanism after 3:30 AM chime

(Fig. 8). The observed crack in the welded seam of the tube element of the fly shaft probably originated at its lower end, *marked 'A'*, where it fitted onto the shaft which carried the bevel wheel used to transmit the drive through the tube. Slow propagation of this crack, within the welded seam along the length of the tube, may have taken place during a substantial portion of the life of the clock. *As noted earlier, this fatigue crack resulted in the failure of the fly shaft.*

The damage to the bottom fly shaft bearing and witness marks on the teeth of the bevel wheel, (Fig 5b) suggest that the lower section of this shaft tilted over during the failure. The damage to the teeth of the bevel on the drive shaft, (Fig 6) and *marked 'B'*, indicates that this wheel was stationary while the partially engaged mating wheel on the fly shaft was still rotating, presumably under the inertia of the displaced fly on the bent fly shaft, which would have disengaged from the upper bearing at this stage and been partially supported by the steady. This implies that the striking mechanism was stopped and held by the locking lever, *marked 'C'*, and that the damage to this wheel followed the striking of the 3:30 AM chimes.

The bevel wheel attached to the fly shaft which already contained fractured spokes, (Fig 5a), probably broke during this stage by jamming the bearing bracket or drive shaft. The failure of this bevel occurred early in the train of events because the portion of the wheel broken off was lying more or less directly under its position in

the clock with its teeth relatively undamaged, marked 'D', also see (Fig. 2; illustration in photo marked a). With the bevel wheels disengaged and without the restraint of the fly governor, the drive shaft when next released at 3:45 AM, would have been able to increase its speed of rotation. When the locking plate actuating lever attempted to stop it, the locking lever could have struck it with sufficient force to break off the end of the locking lever, particularly since it already contained a fairly sharp mechanical groove from which a fatigue crack, (Fig. 4a), had emanated, (Fig. 9).

Without the locking and governor mechanism the drive shaft would have continued to rotate at an increasing rate (reaching an estimated 1600 RPM¹⁷); it was designed to operate at less than 100 RPM, and this conceivably was when the jamming of the locking lever tail and the failure of the drive shafts open ended bearings occurred, (Fig. 10). The locking plate actuating lever and locking plate assembly broke away as a unit with part of the frame still attached, (Fig. 11), and this presumably is when the guide for the actuating lever fractured from an old crack.

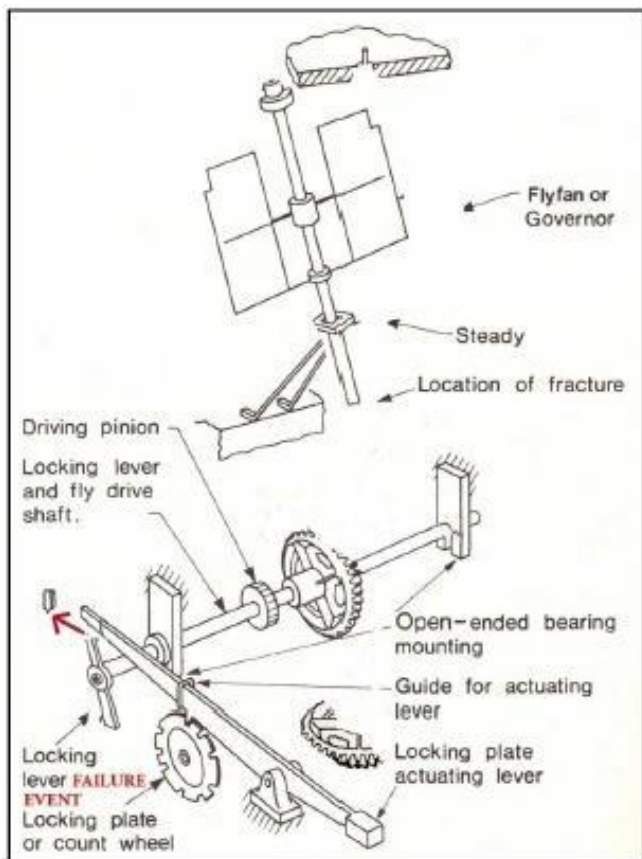

Fig. 9. Governor mechanism post 3:45 AM strike, event 1.

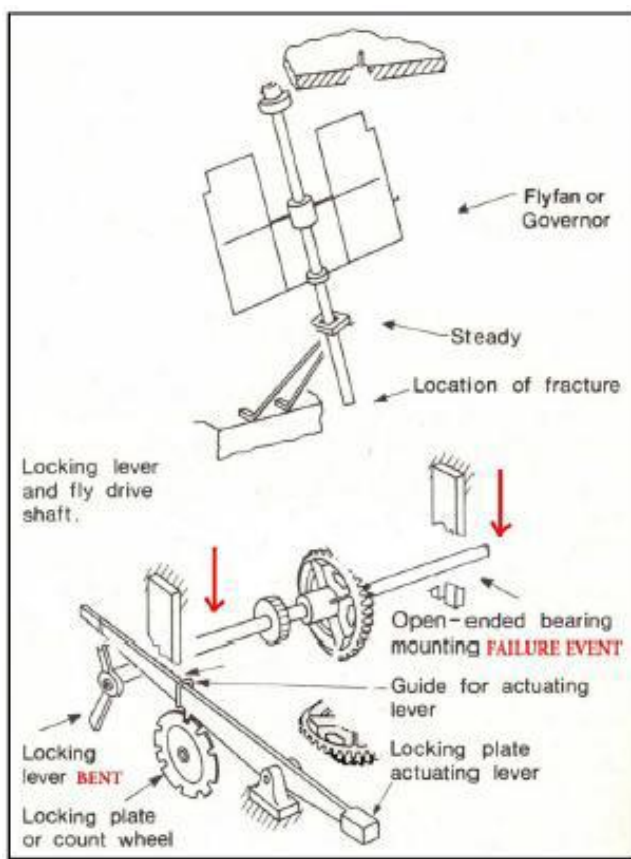

Fig. 10. Governor mechanism post 3:45 AM chime, event 2

With the fly governor and locking constraint removed completely the release of potential energy from the driving weight at 12.5 kN at 40 m (1 ¼ ton/f at 132 ft)*¹ forced the mechanism to operate at speeds in excess of design limits. The single pulley arrangement used on the driving weight would result in the cable unwinding from its drum at twice the velocity of the falling weight. These excessive operational speeds would be expected to lead to parts of the clock mechanism breaking loose and to breakup of the cast iron frame. Early in this train of events the jamming of the quarter bell striking levers on their operating cams, which were designed to operate slowly, would be expected to have imposed sever dynamic impact loading on the frame and mechanism until some of the levers and cams broke, and this section of the frame broke away.

*¹ English ton = 1000 kilo or 2205 lb. so 1 ¼ English ton = 1.38 US ton

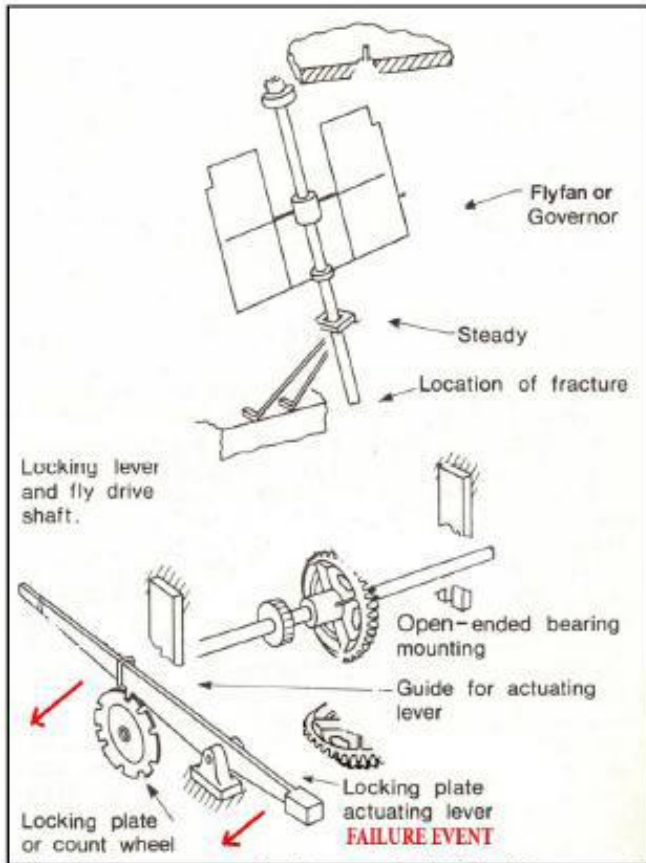

Fig. 11. Governor mechanism post 3:45 AM chime, event 3

Epilog:

As evidence became apparent that fatigue was the likely cause of failure, estimates of cyclic loading were made. In the course of its life of just over 115 years, the quarter chime mechanism would have experienced about 4 million cycles of operation.

Each activation of the striking mechanism would have subjected the fly tube to a torsional shear stress from the torque applied to drive the very large fly vane, which consisted of two paddles 700mm (28 in) wide, 1100mm (43 in) deep with an overall width of 1900mm (75 in). A maximum torque of 85 Nm was estimated based on a speed of 54 rpm being obtained in 1/6 to 1/4 revolution as observed after the mechanism was restored, and was an order of magnitude estimated to overcome the air resistance of the fly vanes. The stresses indicated would be unidirectional since a ratchet mechanism was fitted to prevent the fly from over-driving; the ratchet mechanism was found to be functioning correctly.

So we can eliminate the possibility of this ratchet jamming; jerking the very large fly fan to a sudden stop and the consequently large twisting inertia that would have accompanied such a failure at the point that the chime train comes to its sudden stop as a proximate cause of the tube failure.

The maximum shear stress at the outer diameter of the fly tube, was estimated as not likely to exceed 15 N/mm² (1 ton/f/ in²) when striking the range of quarter chimes. The estimated level of stress was considered to be low for a sound tube and the absence of significant wear on the teeth of the bevel wheels would seem to confirm that the driving torque was not excessive. It is considered that the stress level obtaining would not be expected to exceed the value of the torsional shear fatigue limit of wrought iron, estimated at + or - 120 N/mm² (8 ton/f / in²), or 0.6 times the rotating bending fatigue limit. A very large margin of safety.

After an exhaustive analysis of the rest of the clock mechanism many other components were found to have fatigue cracks. Examples are the very same bevel wheel and fly fan tube assemblies on the hour strike side. The tube was replaced and strike train bevel wheel assemblies were remade from the original cast iron to a machined bronze. All other damaged and defective cast iron wheels were remade in bronze. *End of official report.*

What does one take away from the above analysis?

Was this failure an improbable sequence of events like that which doomed the Titanic?

A series of adverse occurrences that all had to happen in specific sequence to doom what would otherwise be a very safe design? To some degree, yes.

1. Had the wheels of the clock been made of conventional brass material as is common in most tower clocks, particularly from England, it's improbable that cracks would have developed in the bevel wheels.
2. Had the fly shaft bevel wheel not already been compromised with structural cracks; it probably would not have broken apart when the time the fly tube failed at the end of the 3:30 AM chime sequence.
3. Had this disintegration not happened, it is likely that when the fly shaft bevel wheel was tilted out of position from its normal horizontal setting, it would have jammed the mating drive bevel preventing the runaway from initiating at 3:45 AM.
4. Had the fly fan not had the 'steady' assembly, or if the assembly had been weaker (it was not designed to hold the weight of the fly only to guide the tube) or if the fly tube had failed in an area between the steady and the fly, the top portion of the fly may not have been held upright and in place by the steady, and thus been free to collapse onto and perhaps into the mechanism below; jamming up the wheel works.
5. Had the weights not been recently wound to their full height, there would not have been as much energy to be released when the uncontrolled decent began.
6. Had the fly shaft failed at the fourth quarter sequence, rather than the second, the runaway would have had a shorter duration before engagement of the locking lever at the next sequence. In other words the quarter vs. the three quarter sequence; a 300% reduction in the time for the runaway to gain acceleration.
7. Had the locking lever not already been compromised by a fatigue crack it *may* have been able to stop the runaway. This is only a possibility as the chimes would have had a good deal of time to gain speed since it was performing the 3:45 sequence – the next to longest after the hour; before that lever would have been brought to bear.

On the other hand, considering the extensive structural damage to the frame, the clock avoided by sheer luck a fate that would have surely ended its existence once and for all. The fifteen foot, five ton mechanism's frame is supported only by two masonry piers located at either end of the frame, leaving the frame to support not only its own 5 ton weight between these two points but the combined three train weights totaling an additional 2 ½ tons. The accident caused the frame to be broken in five places. These occurred on the far right side of the frame; concentrated in the area where the chime train disintegrated. Had there been further frame damage, or damage nearer the center, the clock could well have broke in half and under the influence of its own and that of the remaining two train weights been pulled into the weight shaft; falling 180 feet to utter destruction.

Aftermath – never again!

Remarkably, considering the damage that was wrought upon the clock, the time train was able to be restarted that very afternoon. In the morning two heavy duty jacks, each capable of raising three tons, were brought up to the clock room in order to support the broken bedplate, and throughout the day work continued on clearing the debris. There was shrapnel damage to the Denison escapement, but as luck would have it, there just happened to be a spare in a cupboard in the clock room at hand! Many years earlier the original escapement had been damaged and a new one fitted. The original had been repaired and kept as a spare; so the great clock

got a heart transplant on the spot.¹⁸ The British take their national symbol very seriously, it's like the heartbeat of the nation and while it may seem reckless to restart the clock immediately after such a serious event that is what was done. This is also the reason for the lack of extensive photographic evidence of the accident. It was cleaned up in a matter of hours after the discovery.

Once the clock was restarted a meeting was held in the clock room to consider the possibility of a full repair of the mechanism with the complete replacement of the chiming train. Present at the meeting was Robert Cooke, Chairman of the Accommodation Commission (those commissions again!), Geoffrey Buggins, managing director of Thwaites and Reed the clock maintenance contractor, and John Darwin the resident engineer of the palace, on whom fell the responsibility of restoring the clock to full working order. Mr. Cooke stressed the need for full restoration of the clock, drawing attention to its special importance as the symbol of Britain and an integral part of the Houses of Parliament. He also reminded the others that Her Majesty the Queen was due to visit the Palace of Westminster in almost exactly nine months' time to receive the Loyal Address of both Houses of Parliament on the occasion of her Silver Jubilee. His committee considered it essential that Her Majesty should be welcomed with the full of Big Ben as she arrived at noon on May 4, 1977. Mr. Buggins took a more cautious approach, advising that although his firm had the expertise and the facilities to undertake the massive task of repairing and reconstructing the clock, he estimated that the work would take at least fifteen months, and so would not be complete until November 1977. Additionally, outside the meeting several 'philistines' were muttering that it might be time to scrap the antique clockwork movement and replace it with modern electric synchronous motors. Mr. Darwin felt it just might be possible to meet the date of May 1977, and after further deliberations this was adopted as the target.¹⁷

Again, it may seem odd to an American that the government would go through such extra expense and efforts just to meet an artificial date, but we have no such lengthy history of ceremonial ritual and no American politician commands a fraction of respect that the Queen does from the people of that country.

The repair work was performed by Thwaites and Reed, which had maintained the clock since 1971. This long established company, which had bid unsuccessfully over a century earlier for the job to build the clock, was now in a unique position as it was completely familiar with its workings.



Fig. 12. Inertial safety brake installed on both strike main wheels.

Since the clock was considered a priceless antique, great care was to be taken to ensure that the appearance remained the same, or as near possible, to the original. One exception to this requirement was that while the original wheels were made of cast iron, all replacement wheels were made of bronze, a much more reliable material. Of course the old welded-seam fly tubes were also replaced with tubes made of modern high strength material. To insure that such an accident could never happen again, Britain's National Physics Laboratory designed a unique brake system, (Fig. 12), that will cause the great wheel to be stopped if it senses that the wheel is turning more than twice its normal speed. One was installed on each strike train.

Through the heroic efforts of Thwaites and Reed the work was completed on April 30 and the bells tested on May 1st, just three days before the Queen's visit to parliament.

Major overhaul of August through November of 2007:

The following photos and some text are excerpted from an article written by Chris McKay in the Horological Journal, January - February 2008.

Almost exactly 30 years later in August 2007 the clock went through an extensive maintenance program to be sure it would be in top condition for its 150th anniversary. Why was an extensive restoration needed? Wear had been noticed in the striking train where the strike barrel was seen rubbing on the great wheel during winding, **Photo 1**. On the going train the lantern pinions trundles on the escapement arbor were getting deeply worn, **Photo 2**.



1. Rear view of hour strike barrel. Bolt heads were rubbing.

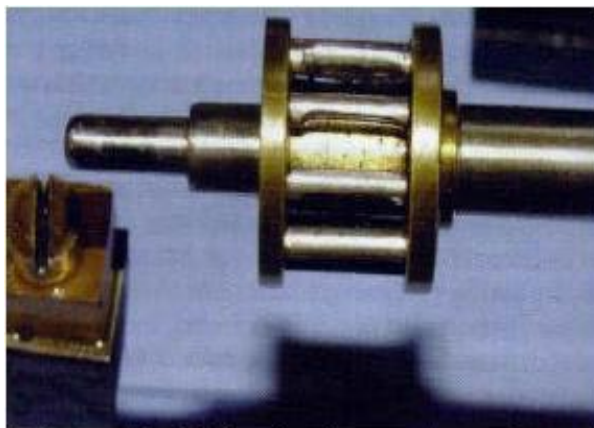

2. Escape wheel pinion, showing wear on trundles.

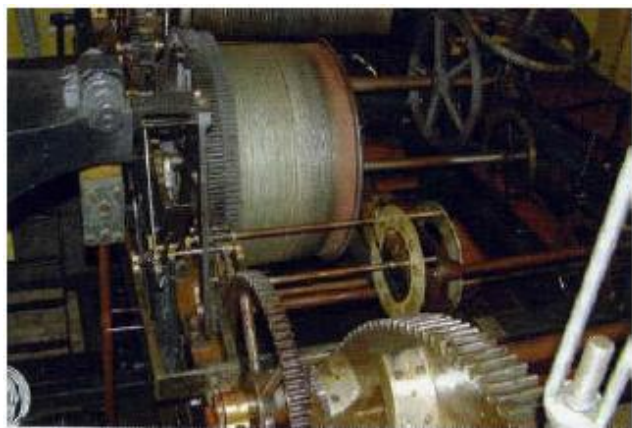

3. Movement view. Note replaced bronze strike wheel and cams.



4. Team of Palace horologists.

In **Photo 3**, notice in the lower right the portion of the quarter strike train that was replaced after the accident in 1976. It was remanufactured in bronze to avoid the types of fractures that plagued the original cast iron material. Ian Westworth, Paul Robertson and Huw Smith are the three Palace clockmakers, **Photo 4**. Apart from making three visits a week up the tower to the clock for maintenance and winding, they are responsible for winding, servicing and repair of the over 1000 clocks in the palace as well. Some of you with large clock collections thought you had a lot of winding and repair work! Six to eight weeks were allocated for the work. Since it was decided to keep the hands telling time, an early task was to specify a synchronous drive unit that would neatly fit next to the bevel wheel cluster. A special unit was commissioned, **Photo 5**, next page, built and tested at full load.

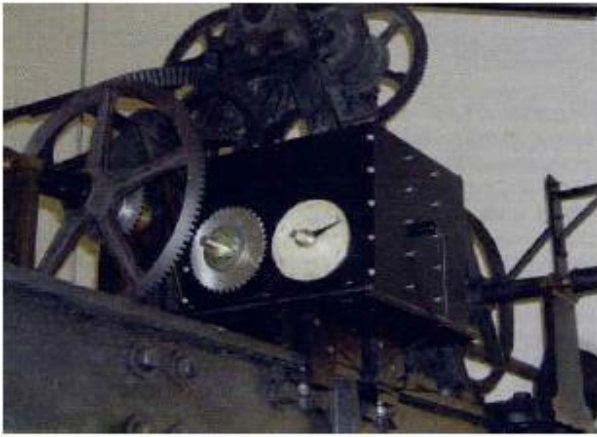

5. Temporary synchronous motor drive unit.



6. Scaffolding to enable the lifting of heavy parts

Before any large parts could be removed, scaffolding had to be erected around the clock, **Photo 6**. From this chain blocks were attached.



7. The Palace team lifting out the hour strike barrel



8. Cradle for strike barrel

But before this was done, all the lesser wheels and other parts that could be damaged from a fall from the overhead scaffold structure were removed. Only then, **Photo 7**, were the main strike barrels lifted out from the mechanism. Since the main strike barrels were to be removed and brought to the ground, two cradles were made to safely hold the barrels, **Photos 8 and 9**, while workers removed the great wheels from the barrels.



9. Safely in the cradle, the great wheel is removed from the barrel.



10. Strike barrel being lowered down the stair well.

This was necessary as they would not fit down the stairway shaft as a unit, **Photo 10**, prior page. The barrels were then lowered down to the ground. Remember that this was not the way the original clock was hoisted up to the tower, the original clock frame and parts were hoisted up the weight shaft which is a quite bit larger (8 x 11 feet), but is now covered by the movement itself preventing its use.

A rarely seen view; **Photo 11**, the internal pilot and setting dial at the rear of the clock. The nut on the gear wheel is one of two that clamp up the hand setting mechanism. Nothing subtle about this one, unlike many smaller tower clocks that have more user-friendly hand release clutches or knurled lockdown knobs!



11. Internal setting dial at the rear of the clock.



12. Scaffold to reach the 12 feet to the motion works.

Since the hour tube is about 12 feet from the floor, scaffolding was installed to reach the behind-the-dial components, **Photo 12**. The tubes reaching the hands are supported by roller wheels. There are two sets of these for each dial for the hour and minute arbors. In the past some of these rollers had seized up leading to flats on the surfaces of some of these rollers. This is an indication of the sheer power that is delivered by the movement, **Photos 13 and 14**.

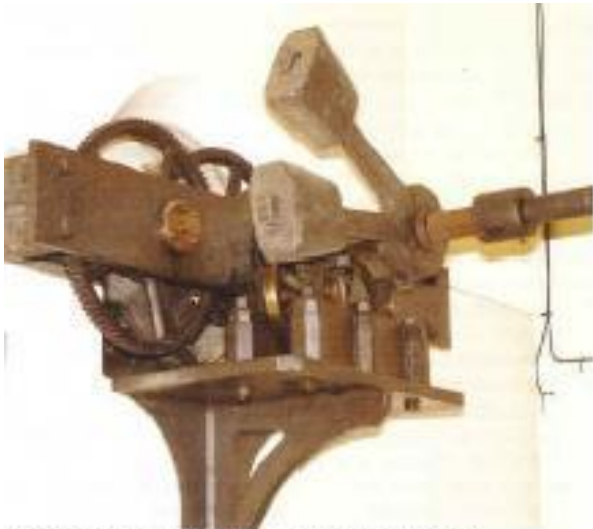

13. Internal hand counter-weights.



14. Friction rollers behind the dial.

An inspection of the going barrel's arbor keyed collet revealed more of the dreaded stress cracks. These were mated to tapered keys that were on the arbor and originally hammered into place to secure the assembly, **Photo 15**. The crack was repaired with a method called 'cold stitching', a technique used to repair castings. A series of holes is drilled using a custom jig, the series of holes being at right angles to the crack, **Photo 16**. A specially shaped lock insert is put into the hole and secured with a resin. The lock is made from a high nickel steel alloy and is much stronger than the surrounding cast iron.



15. Cracks in going great wheel hub.



16. Repair using cold stitches that look like a row of filled holes.

All bushes were replaced with new bronze, and it was decided to make a new arbor. The going barrel needed new bronze bushes, **Photo 17**. The old thrust washer had worn thin which lead to the end bolts mounted on the barrel to rub on the great wheel arms when being wound, and was replaced. With the flat bed frame stripped of most parts, **Photo 18**, the frame members were inspected and other parts were inspected and cleaned.



17. Going barrel before bush and washer replacement.



18. Clock frame stripped of parts, ready for inspection.

As the major components came back from the engineering works they were hoisted up the tower and installed; the going train first, then the striking **Photo 19**, next page. The strike barrel great wheel and arbor are first tested for true and smooth running. Afterward the huge barrel is installed and everything tested again, **Photo 20**, next page. Train and winding wheels were then reinstalled along with all the locking and release levers. Other work, on a smaller scale **Photos 21 and 22**, next page, was carried out on the escapement itself, replacing the worn lantern pinion rods.

The clock was restarted October, 7 weeks after the job began. Everything ran according to plan.



19. Strike great wheel and arbor being installed.



20. Strike wheel and barrel together and installed.



21. Drilling the lantern pinion of the escapement.



22. Finished lantern pinion with new trundles.

Notice in the final picture, **Photo 23**, below the additional pillars that are permanently attached to the clock frame under the area where it suffered the most damage; the chiming train. While the frame was repaired and welded, no chances are being taken with this area that will always be exposed to high mechanical stresses.

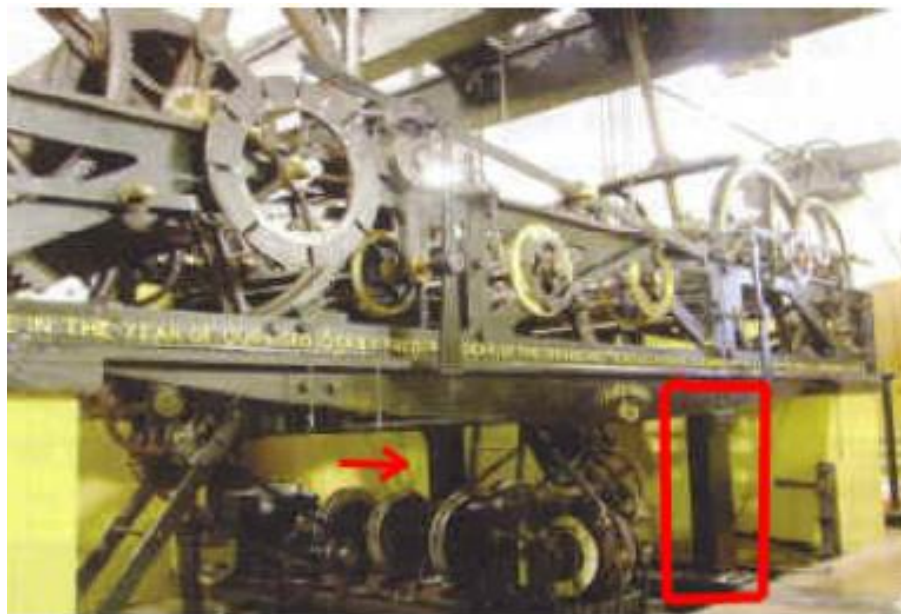

23. Additional support columns under areas where frame was broken.

Appendix

The original letter written by Edmund Denison to George Biddle Airy on November 27, 1852. Here he first describes his inertial fly fan innovation which leads to the first practical gravity escapement.

2 sec. Pendulum of 686 lbs requires not more than 16 lbs falling 4 ft a day to keep it vibrating.

$\Delta =$ increase of time of a vibration of a free pendulum due to this escapement $= \frac{Wh}{T \sin \alpha^2} \sqrt{\frac{\alpha^2}{\gamma^2} - 1}$

$\gamma =$ \angle of change of arms
 $\alpha =$ extremum arc
 $T =$ no of vibrations in a day

$\therefore d\Delta T = -$ 'daily rate' $= \frac{Wh}{T \sin \alpha^2} \frac{1 - \frac{2\gamma^2}{\alpha^2}}{\sqrt{\frac{\alpha^2}{\gamma^2} - 1}} \frac{d\alpha}{\alpha}$

$= 0$ if $\alpha = \gamma\sqrt{2}$

But let $\alpha = 2^\circ$ $\gamma = 1^\circ = .0175$ $d\alpha = 5'$ & suppose the arc to diminish $5'$ Then

daily rate $= \frac{16 \times 4}{686 \times 13\pi} \frac{1}{\sqrt{3}} \frac{1}{24} \frac{1}{(.0175)^2} = .09$ $\frac{\text{sec}}{\text{day}}$

~~is~~ $\frac{1}{10}$ of second error; whereas the corresponding \odot^r error is .6 sec.

$\therefore \gamma$ may safely be made $\frac{\alpha}{2}$ which is more convenient in practice on several accounts, giving greater depth of locking, & greater weight of arms, & a slower movement of them.

As it is found that even if the escapement sends the arms a little too far (not actually tripping, which the fly prevents) they will fall down again, the pressure & friction on the stops being too small.

This gets rid of the approach to tripping, which has been the great source of error in gravity escapements, as it alters the amount of the impulse.

The stops, screw heads, & impulse pins are behind.
~~The stops are adjustable.~~
 The stops are adjustable.
 Large cocks coming between arms & pendulum, & clear of the fly.
 Eccentric fork pins
 Braking pins pointing backwards from cock
 range of fly behind screw

Footnotes and Bibliography:

1. Big Ben - It's Engineering Past and Future, The Engineering Sciences Division of the Institution of Mechanical Engineers, pp A1
2. The following internet resource was used: <http://www.measuringworth.com/ppoweruk/> currency calculator. This calculator gives figures according to either the 'retail price index' or the 'average earnings index'. The latter results in figures roughly ten times the former and amounts that are out of proportion to what one would expect for individual items. The later index would reflect the general increase of the average wage earners standard of living. I've used retail price index for comparison purposes. Conversion to US Dollars are as of November 2008 when the exchange rate was about 1.60 Dollars to one British Pound.
3. Guinea conversion. At the time 1 Guinea = 21 shillings. There were 20 shillings to the Pound. Therefore 100 Guineas = 2100 shillings/ 20 shillings/ Pound = 105 Pounds. 1 Pound in 1844 = 65 Pounds today. 105 Pounds = 6,825 Pounds today or \$10,920 at a current exchange rate of \$1.60/ Pound in November 2008
4. Edward John Dent and His Successors, Vaudry Mercer, pp. 344
5. Edward John Dent and His Successors, Vaudry Mercer, pp. 347
6. Edward John Dent and His Successors, Vaudry Mercer, pp. 348-350
7. The Triumphs of Big Ben, John Darwin, pp. 90, and Edward John Dent and His Successors, Vaudry Mercer, pp. 345
8. Edward John Dent and His Successors, Vaudry Mercer, pp. 354
9. Dennison's contributions include these unique innovations and inventions:
A practical gravity escapement, the solid cam bell hammer actuator, a striking mechanism allowing hour striking to the nearest second, redesign of the great bell allowing its installation into the already half completed tower and the caged flat bed design based on the truss bridge designs of the day.
10. The Triumphs of Big Ben, John Darwin, pp. 60
11. Big Ben - It's Engineering Past and Future, The Engineering Sciences Division of the Institution of Mechanical Engineers, with reports by the National Physics Laboratory, pp. A14
12. Edward John Dent and His Successors, Vaudry Mercer, pp. 391
13. Table of gravity escapement energy sink from my paper on tower clocks.
Antiquarian Horology, vol. 11, no. 6, Winter 1979. "The Fly in the Grimthorp Gravity Escapement", by Henry Wallman, pp. 629-631. The essence of this article is that the fly acts as an 'energy sink'. Accuracy requires an escapement system that provides a constant impulse to the pendulum despite varying energy demands from the hands (a big factor in the case of tower clocks with ice buildup or wind) and to a lesser degree variations in the wheel train due to oil viscosity induced by temperature and environmental contaminants. When demands are high the fly slows down, however, as long as it moves through its allotted 60 degrees (in the case of the Dennison double three-legged type) within the time it takes the pendulum to make one swing the escapement is unaffected. When demands are low the fly moves quickly, partially dissipating the excess energy as an air brake (i.e. heating the air). But because the fly is attached to the escape arbor through a friction clutch any additional excess energy that would be dissipated by slamming into the pallet stops is instead lost through the sliding of the clutch (again, negligible heat). This last issue is what distinguishes the Dennison gravity escapement from all earlier attempts to solve the tripping problem. The fly device is a non-linear system making it well suited to varying demands. The table below neatly shows how a large change in demand from the external forces acting upon the movement is made into an even stream through the escapement as it reaches the pendulum. The Dennison is indeed a remontoire and escapement in one device - one of a very few practical 'escapement remontoire'.

	<u>Hands under heavy ice load</u>	<u>Good Weather, no wind</u>
Large Wheels	100	100
Hands	200	45
Fly	10	160
Pallet stops	4	9
Unlocking	1	1
Pendulum	<u>5</u>	<u>5</u>
Total (from main weight)	320mJ	320mJ
Conjectured energy flow in 'Big Ben', in millijoules per (two second) beat.		

14. Big Ben - It's Engineering Past and Future, The Engineering Sciences Division of the Institution of Mechanical Engineers, with reports by the National Physics Laboratory, pp. A15
15. A Portion of the Papers Relating To The Great Clock for the New Palace At Westminster, printed by the House of Lords with remarks. Printed, 1848. Available on Google Books.
16. Big Ben - It's Engineering Past and Future, The Engineering Sciences Division of the Institution of Mechanical Engineers, with reports by the National Physics Laboratory, pp. A11
17. Big Ben, The Bell, The Clock and The Tower, Peter Macdonald, pp. 180
18. Big Ben, The Bell, The Clock and The Tower, Peter Macdonald, pp. 175-177
19. A Portion of the Papers Relating To The Great Clock for the New Palace At Westminster, printed by the House of Lords with remarks, pp. 7

I would like to receive any comments or suggestions British Horology members may have about this lecture. My email is mfrank1@rcn.com.

Mark Frank